

Die#: V-014
Size: 3.2165" x 6.2341"
Gap: .25"
Corner Radius: .015625"
Material: Matte WS
Liner: 44pk

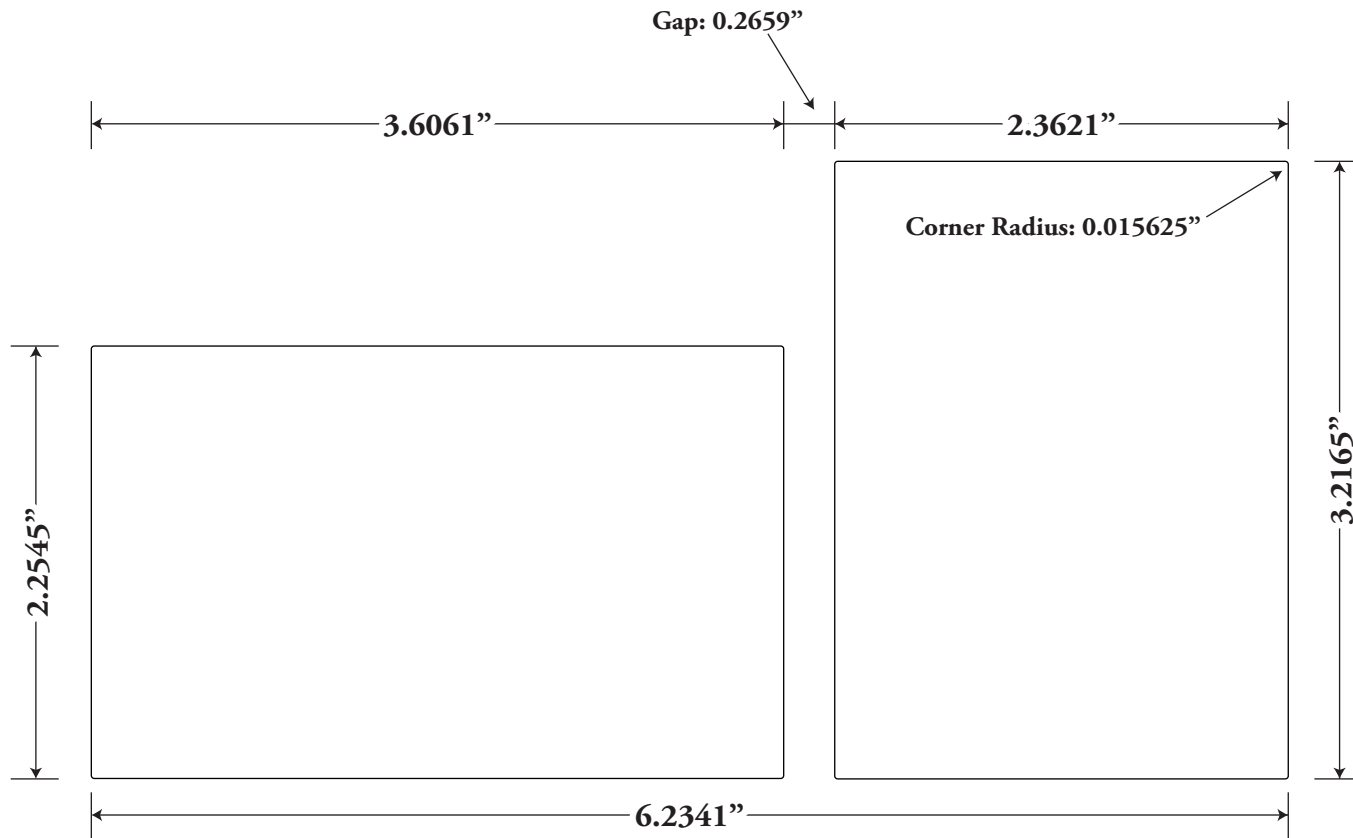

← Run Direction →

Die#: V-049
Size: 4" x 8.125"
Corners: 1/64"
Material Type: CLASSIC CREST
Varnish: GLOSS
Laminate: NONE
Special tooling: NONE

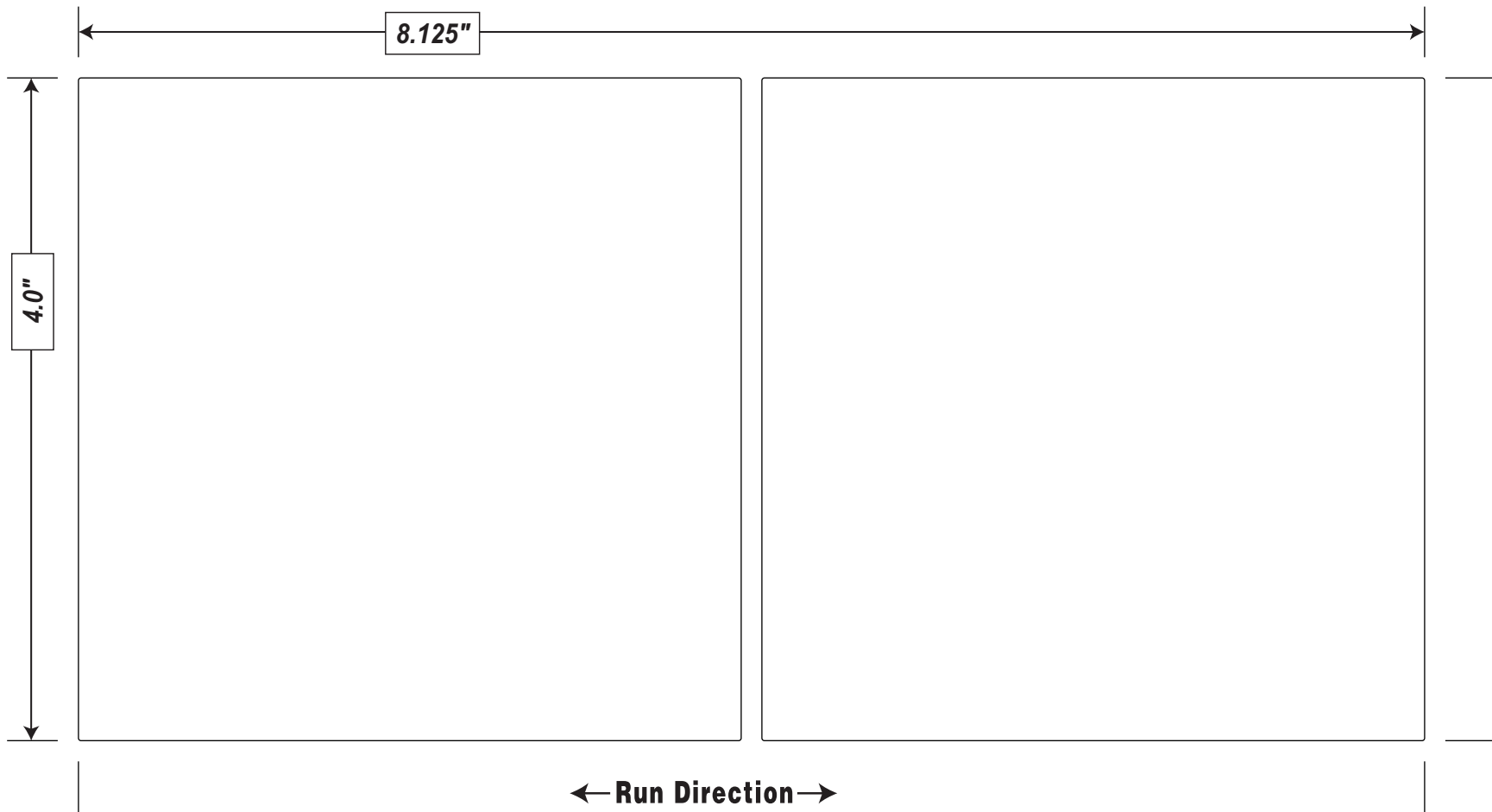

Die#: V-055
Size: 2.75" x 7.5"
Gap: .125"
Corner Radius: .015625"
Material: Gloss
Liner: 44pk

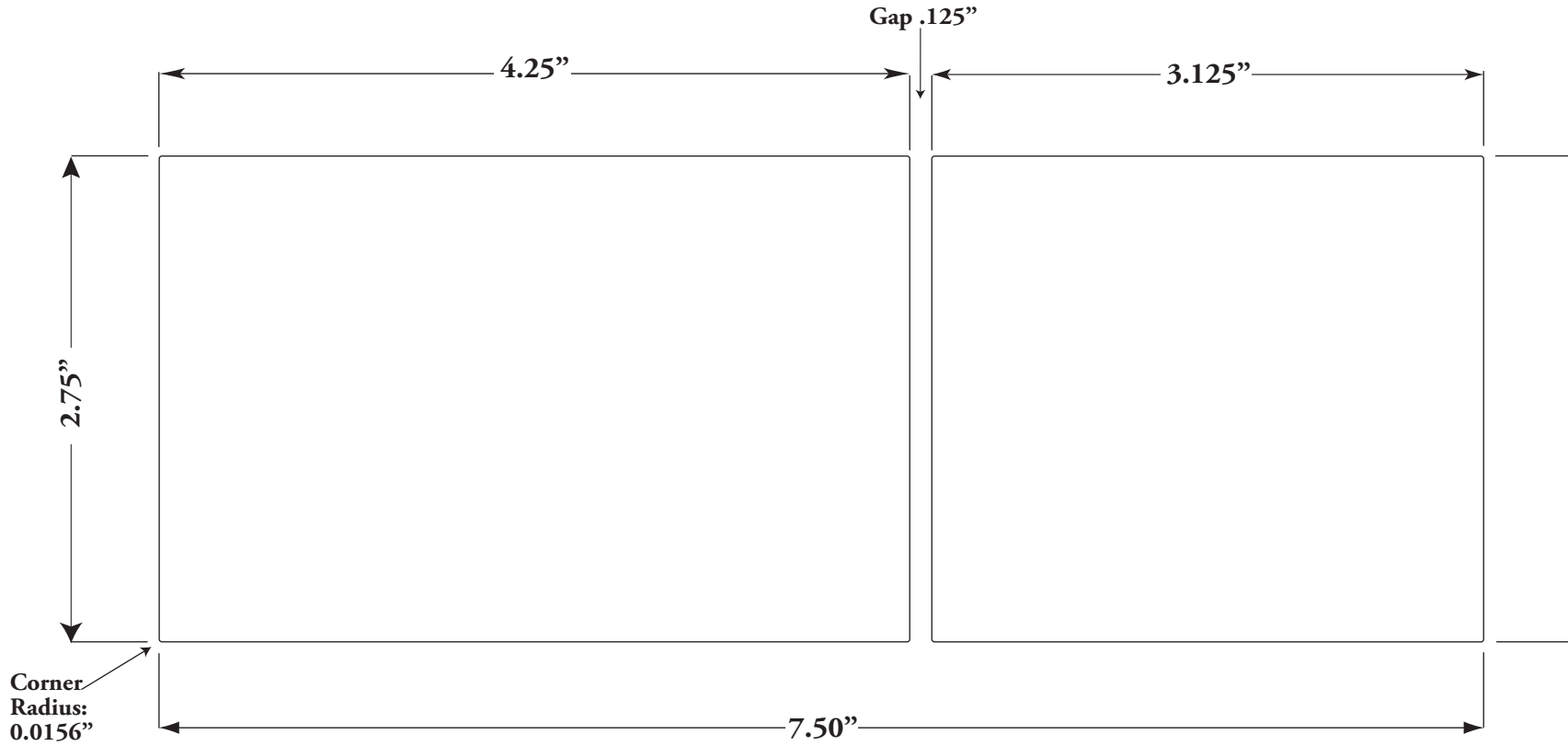

← Run Direction →

Die#: V-074
Size: 3.125" x 8.375"
Gap: .125"
Corner Radius: .015625"
Material: Classic Crest
Liner: 44pk

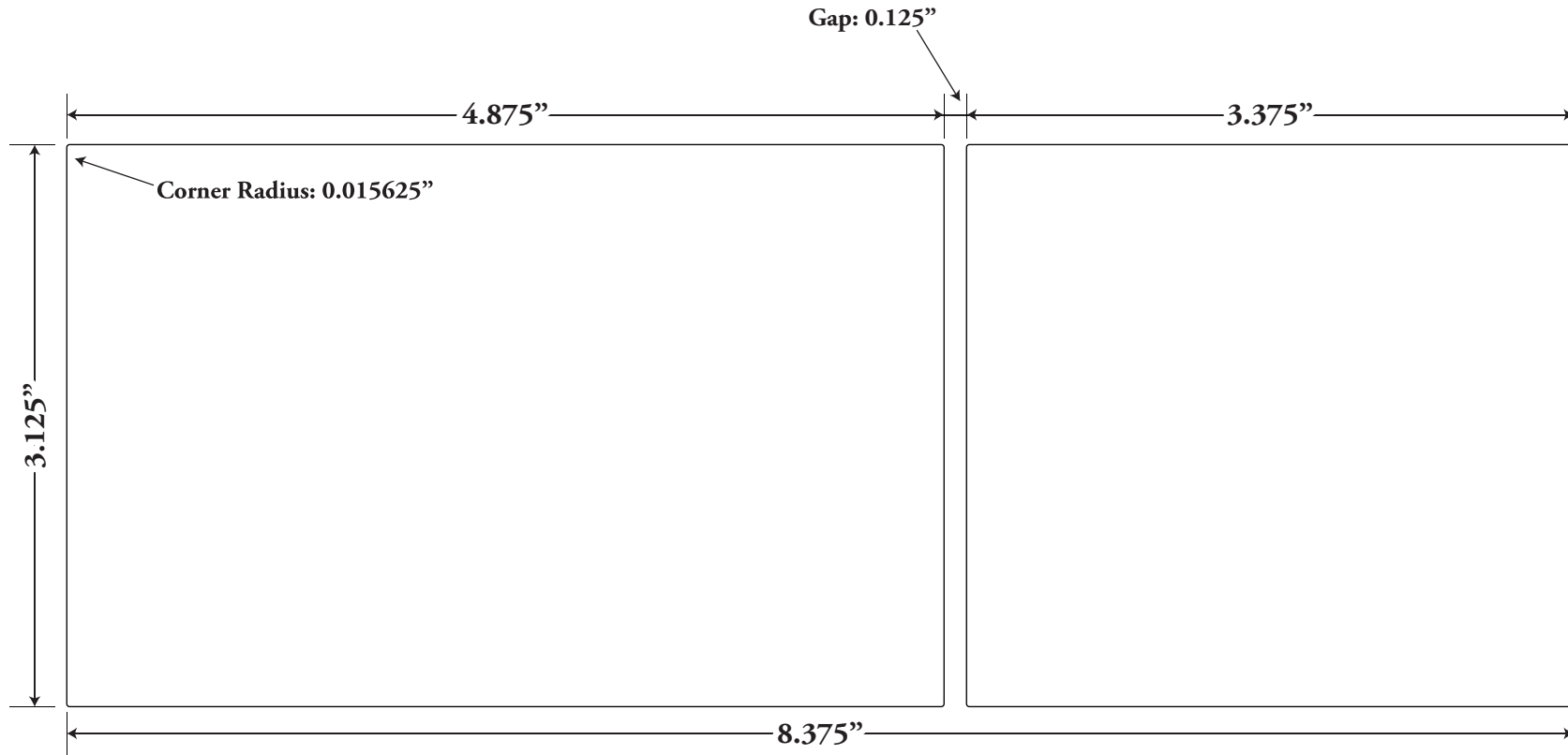

← Run Direction →

Die#: V-081
Size: 2.7" x 7.7175"
Gap: .1575"
Corner Radius: .015625"
Material: Estate 8
Liner: 44pk

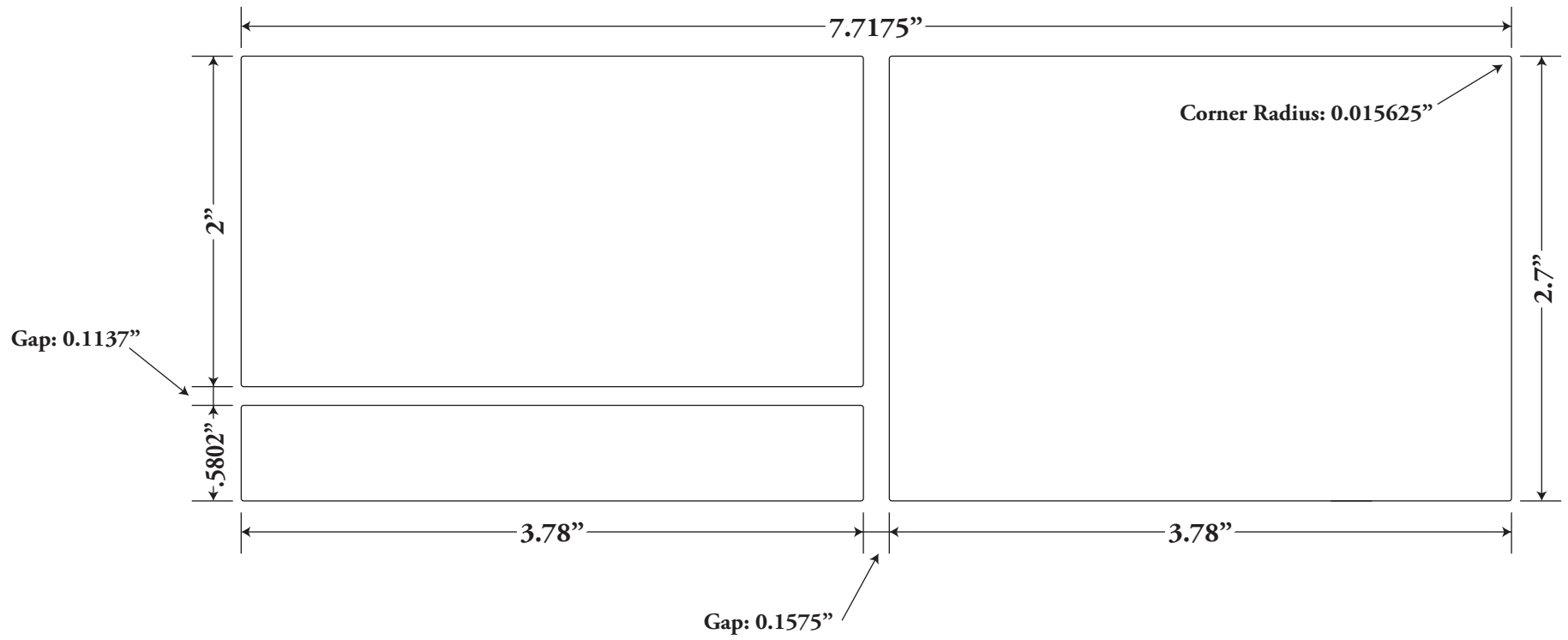

← Run Direction →

Die#: V-100
Size: 3.5" x 6.125"
Gap: .125"
Corner Radius: .015625"
Material: Gloss
Liner: 44pk

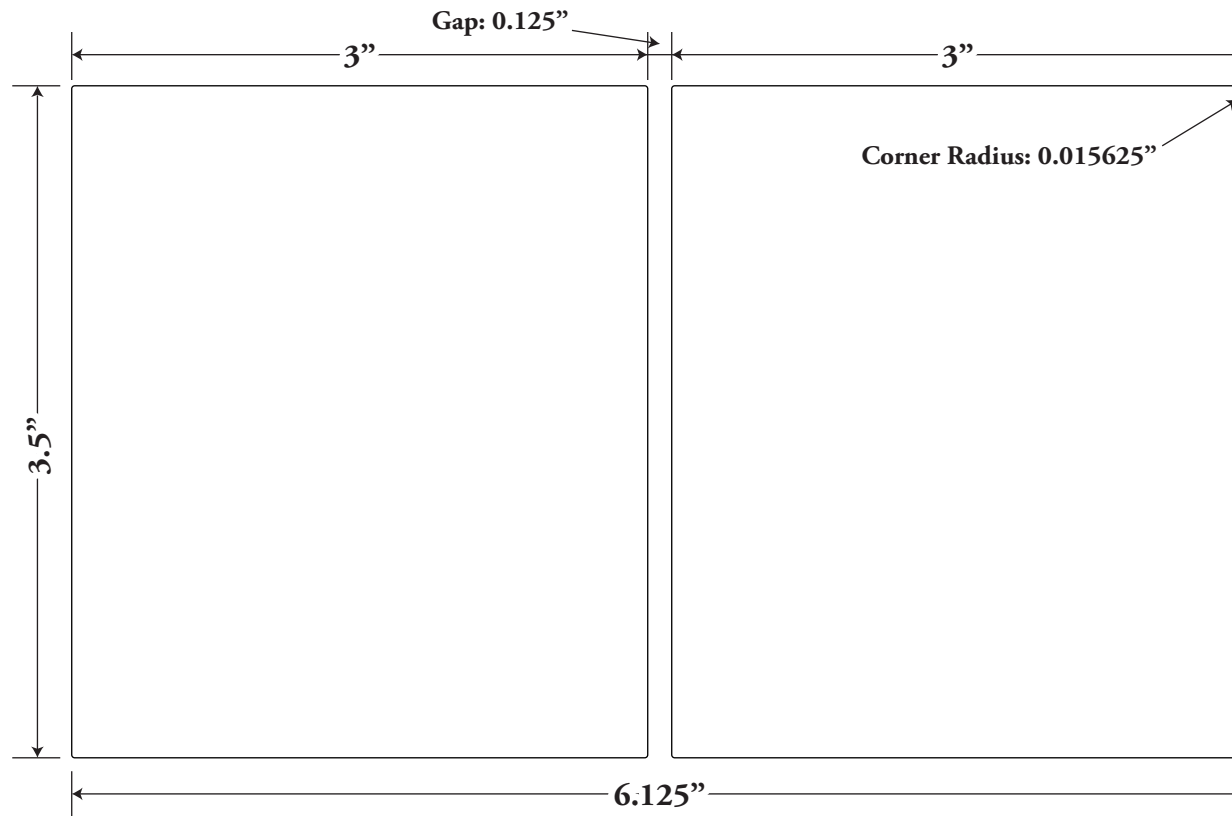

← Run Direction →

Die#: V-104
Size: 3.0" x 6.875"
Gap: .125"
Corner Radius: .0156"
Material: Classic Felt
Liner: 44pk

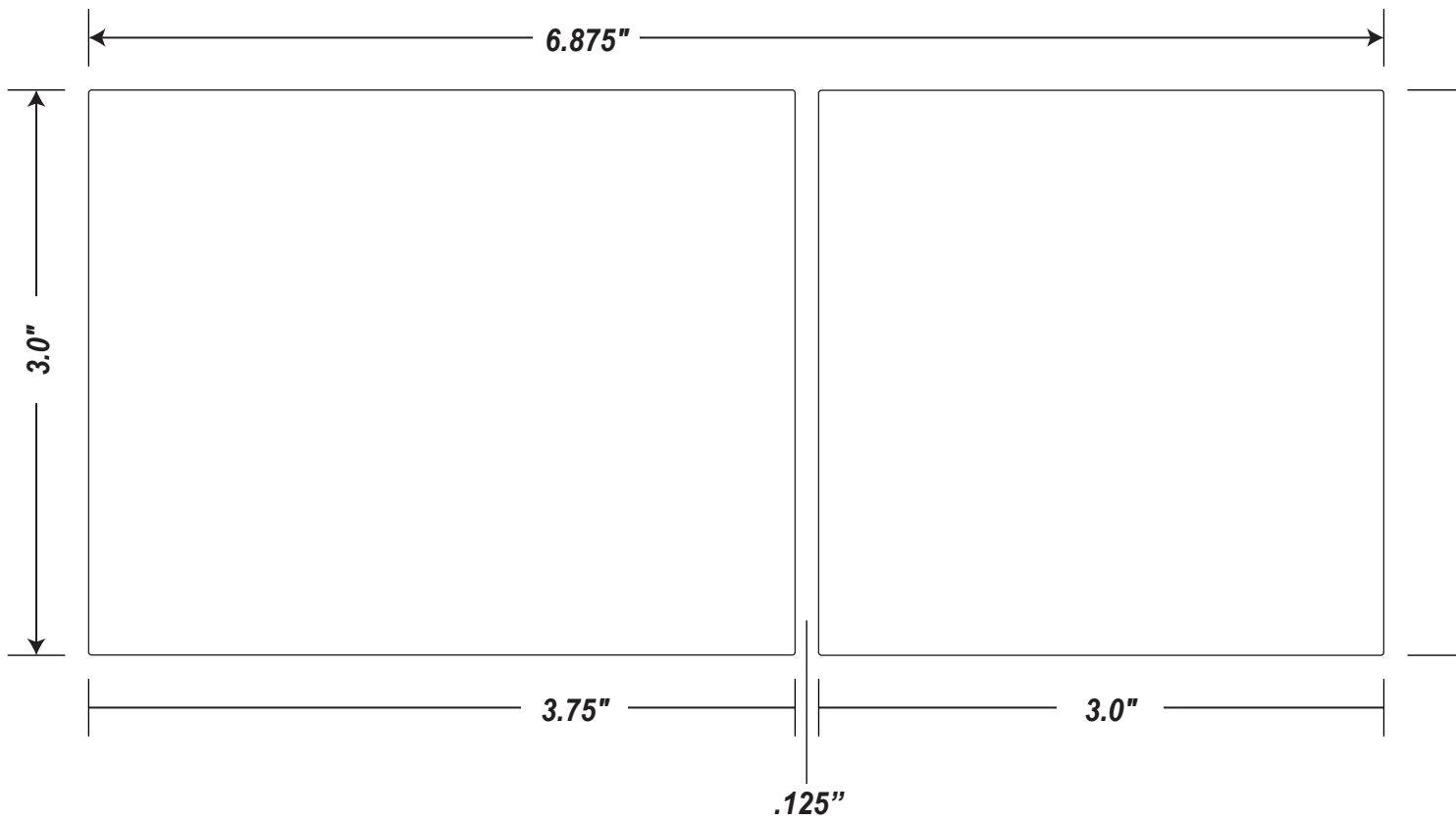

← Run Direction →

Die#: V-113
Size: 3.5" x 7.125"
Gap: .125"
Corner Radius: .015625"
Material: Matte Litho
Liner: 44pk

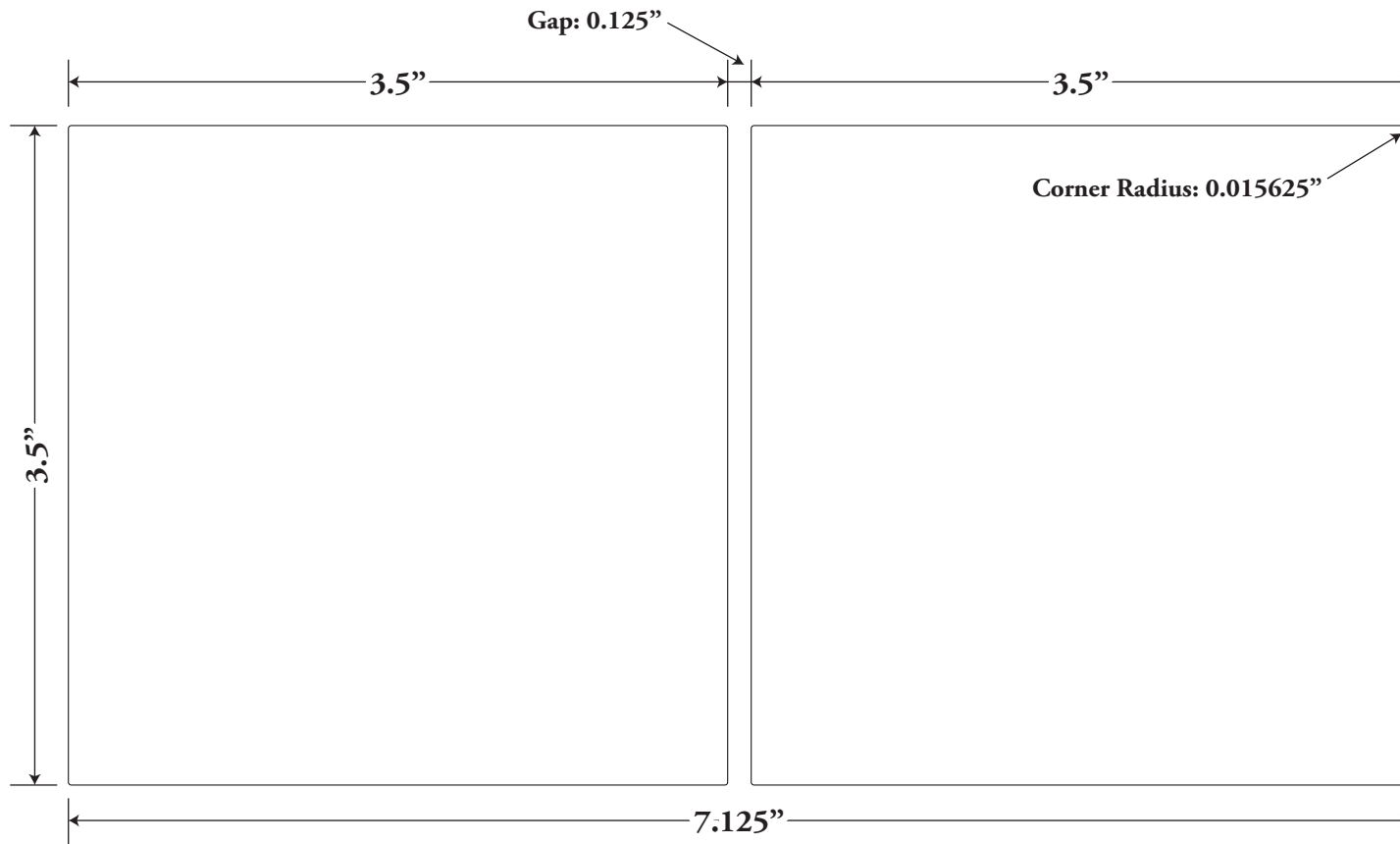

← Run Direction →

Die#: V-115
Size: 4.891" x 5.916"
Gap: .125"
Corner Radius: .015625"
Material: Gloss
Liner: 44pk

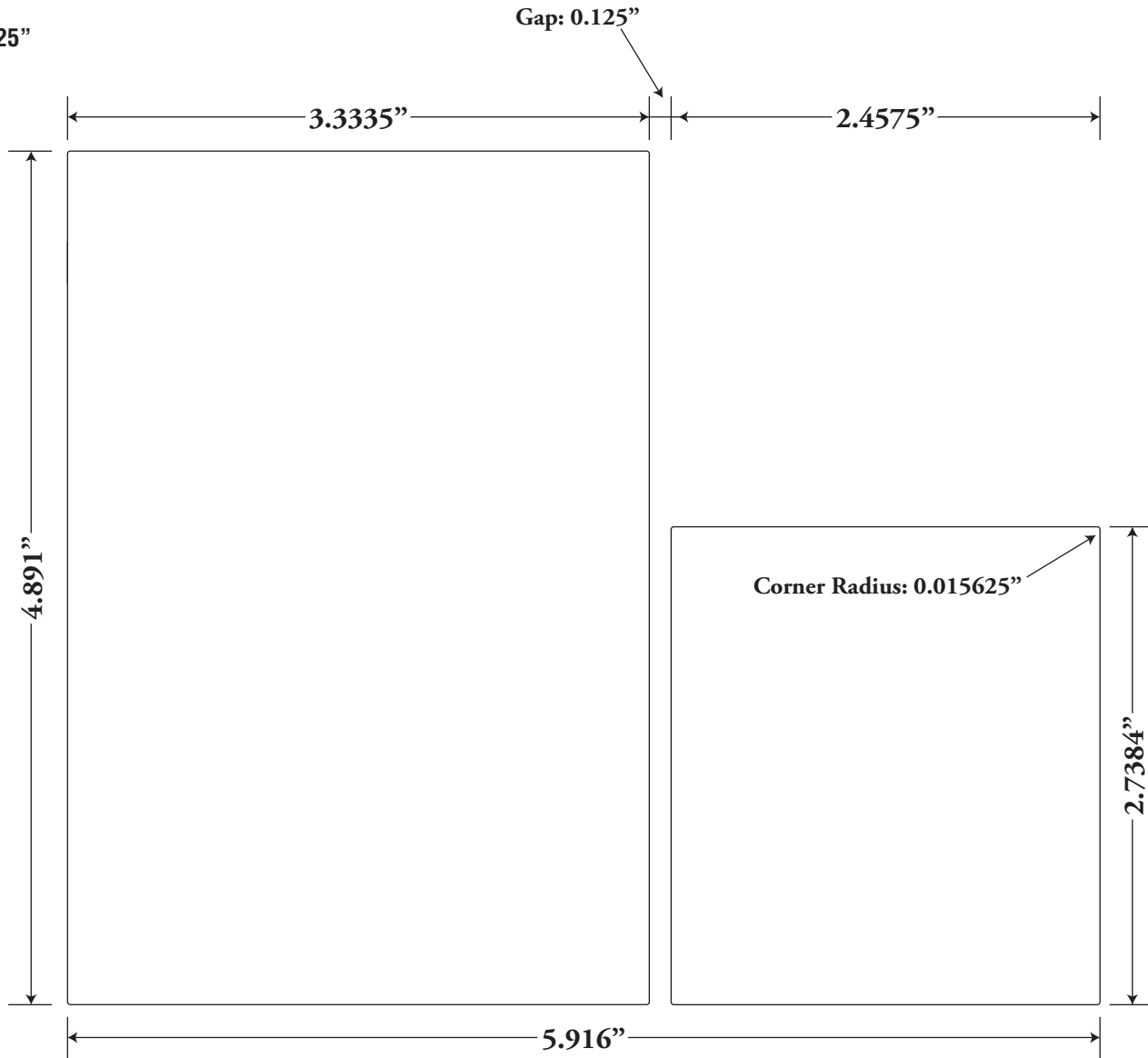

← Run Direction →

Die#: V-118
Size: 2.875" x 5.875"
Gap: .125"
Corner Radius: .015625"
Material: Primax
Liner: 44pk

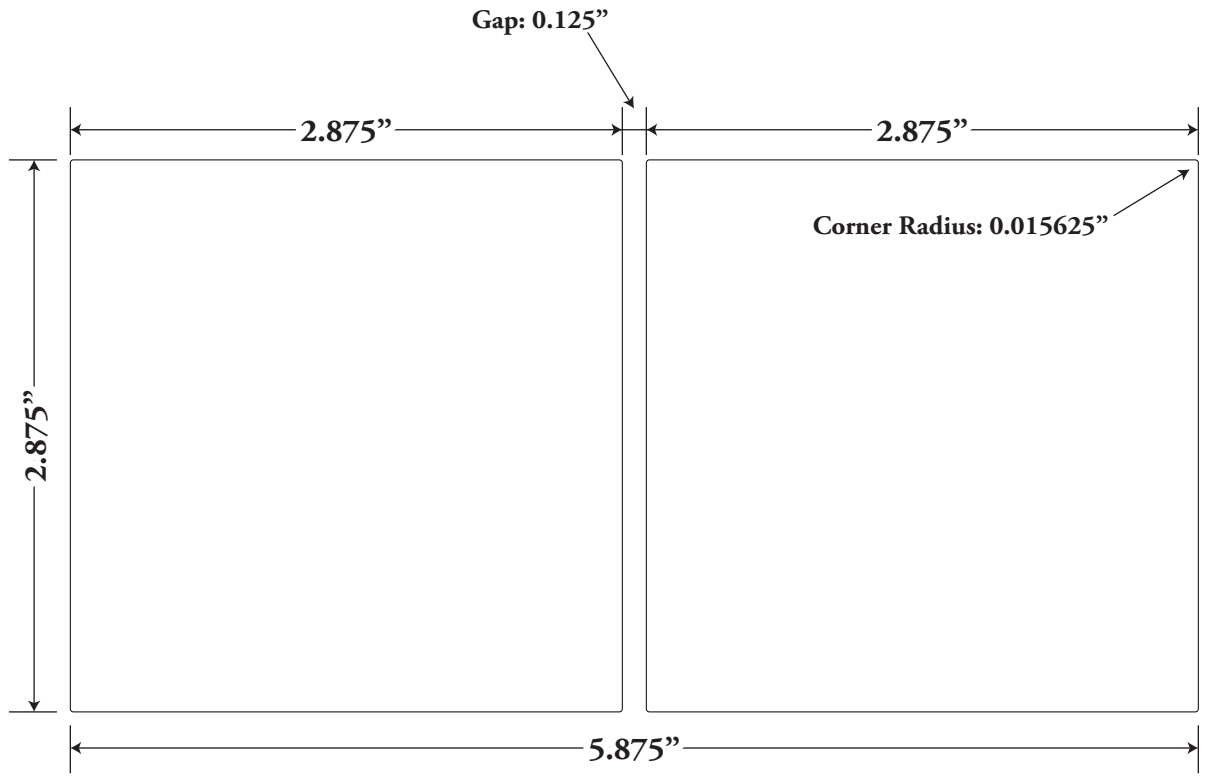

← Run Direction →

Die#: V-121
Size: 4" x 5.625"
Gap: .125"
Corner Radius: .015625"
Material: Matte
Liner: 44pk

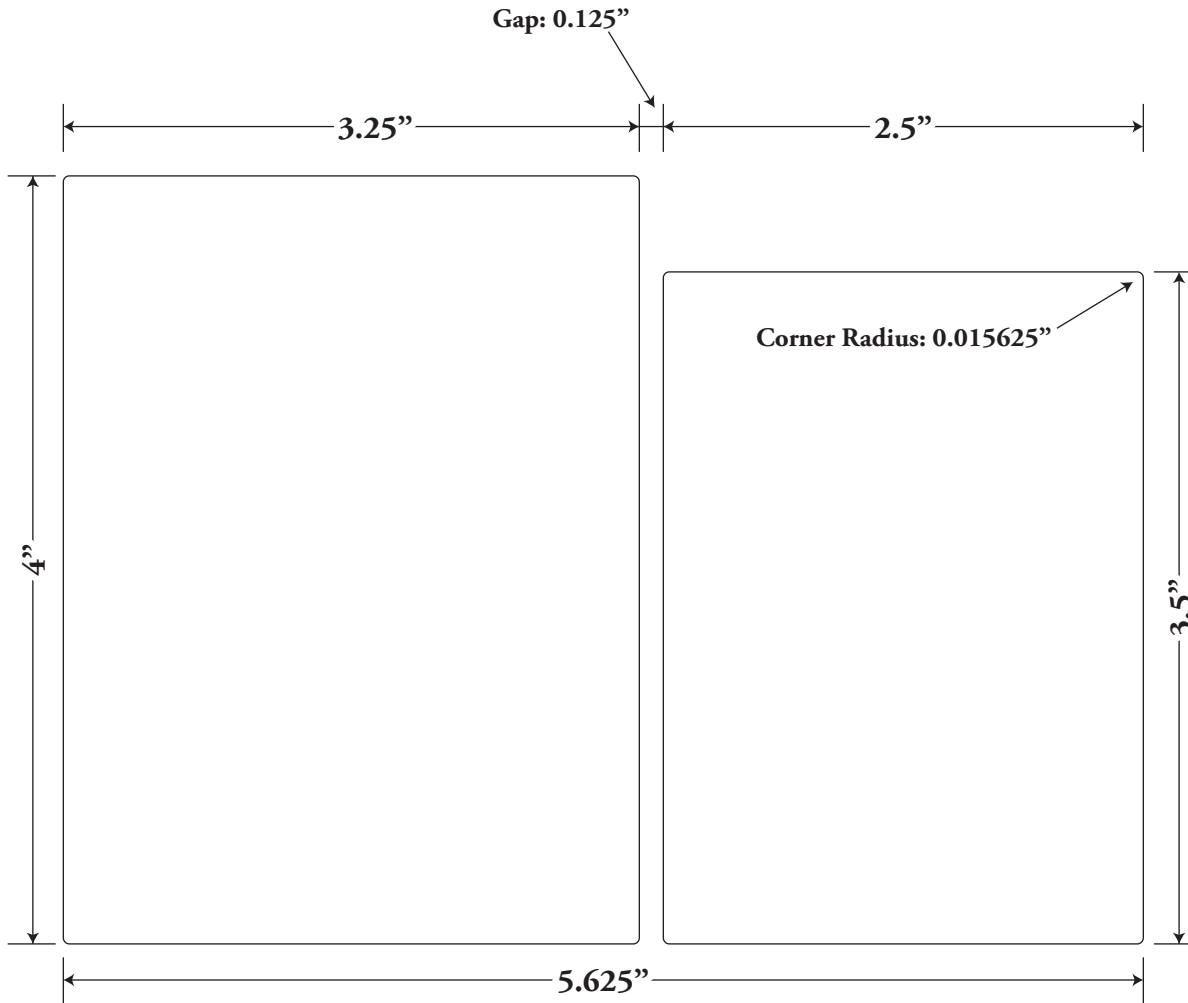

← Run Direction →

Die#: V-122
Size: 3.625" x 6.375"
Gap: .125"
Corner Radius: .015625"
Material: Classic Felt
Liner: 44pk

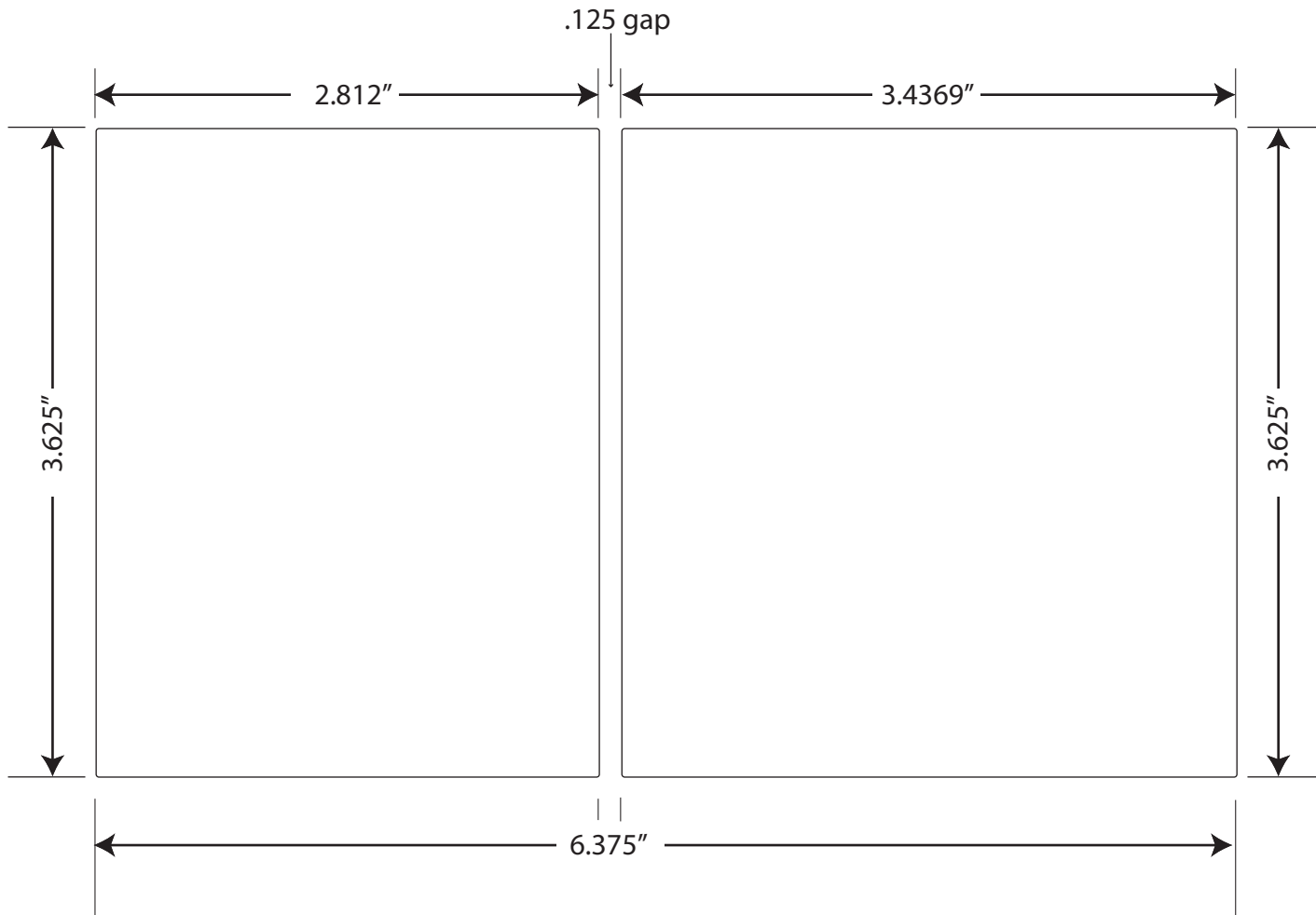

← Run Direction →

Die#: V-124
Size: 3.75" x 6.875"
Gap: .125"
Corner Radius: .015625"
Material: Bright White Felt
Liner: 44pk

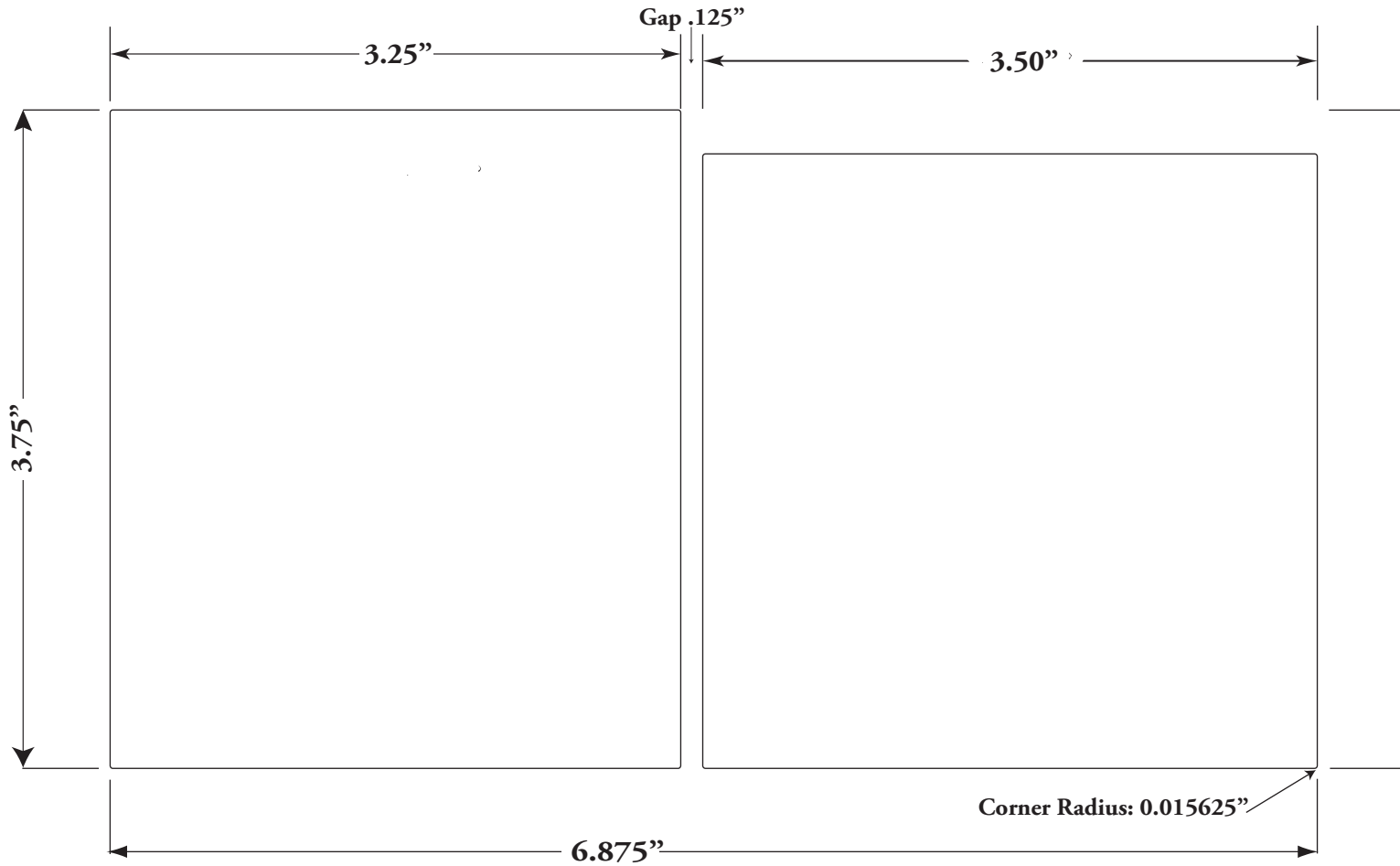

Die#: V-132
Size: 3.75" x 6.5"
Gap: .125"
Corner Radius: .015625"
Material: Classic Felt
Liner: 44pk

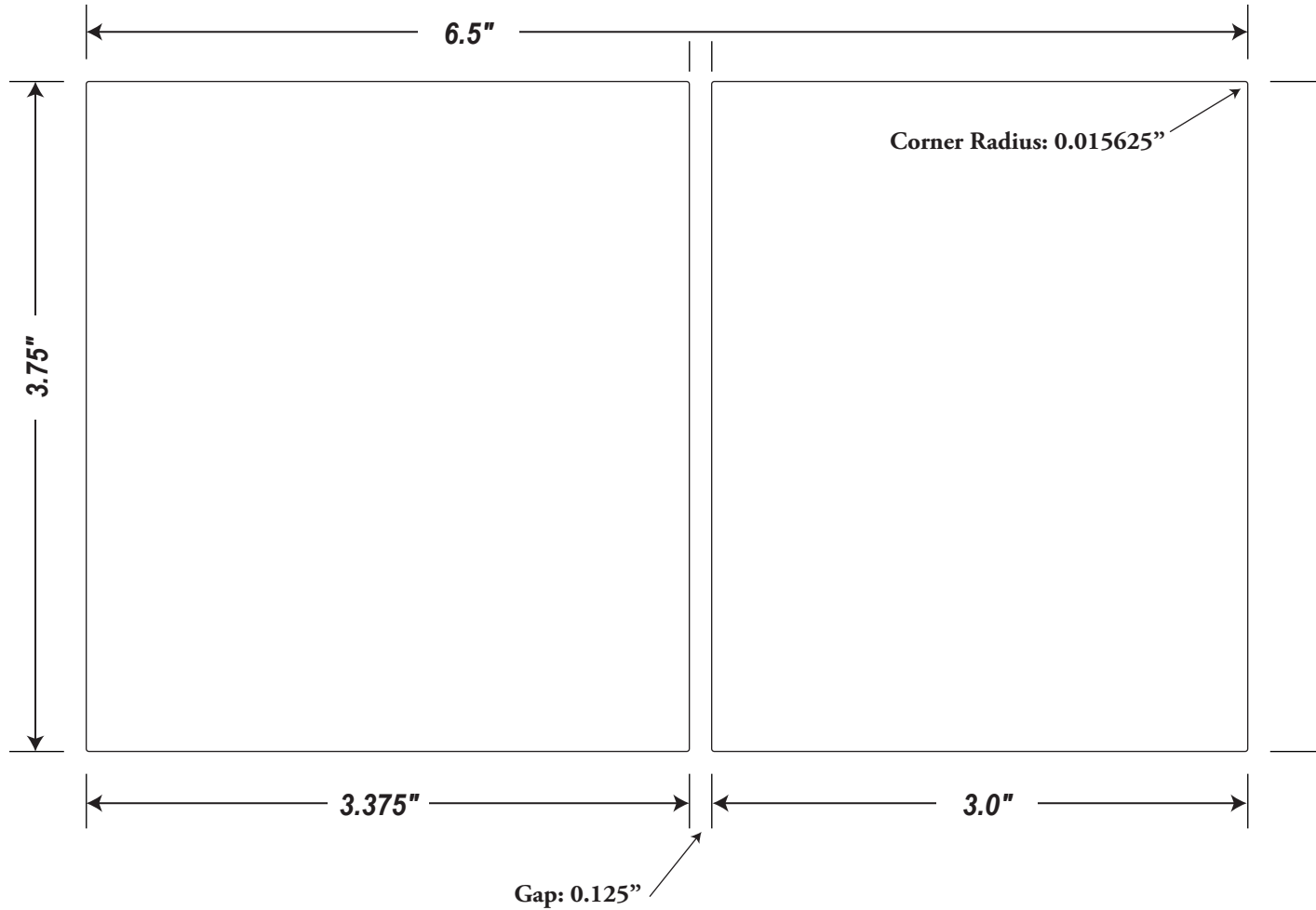

← Run Direction →

Die#: V-133
Size: 3.25" X 8.375"
Corners: 1/64"
Material Type: Classic Felt
Varnish: yes
Laminate: no
Special tooling: Bonham Foil Stamp

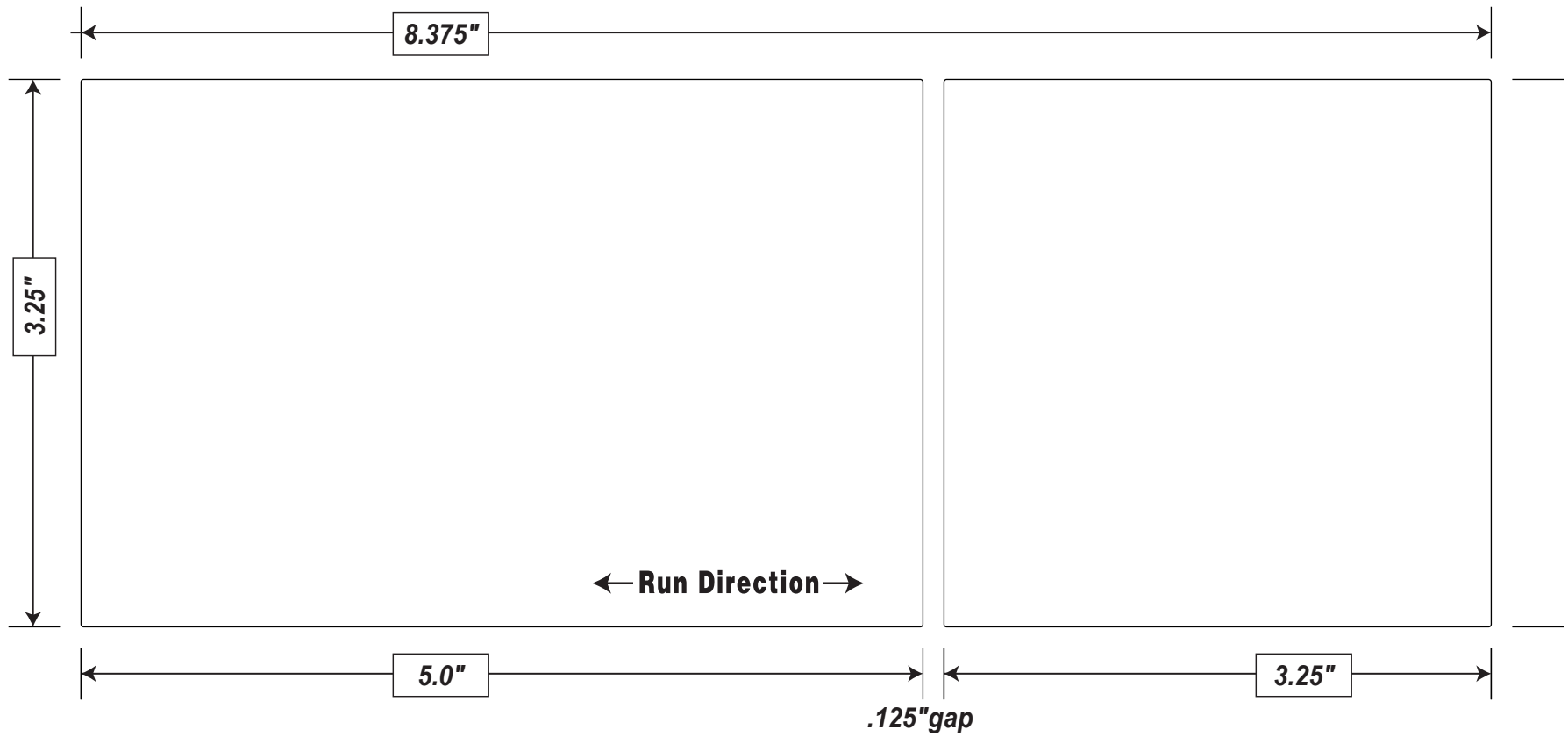

Die#/Size: V-142 4.8585" X 5.85"
Corners: 1/64"
Material Type: Classic Crest
Varnish: Satin 2
Laminate: None
Shape: Special

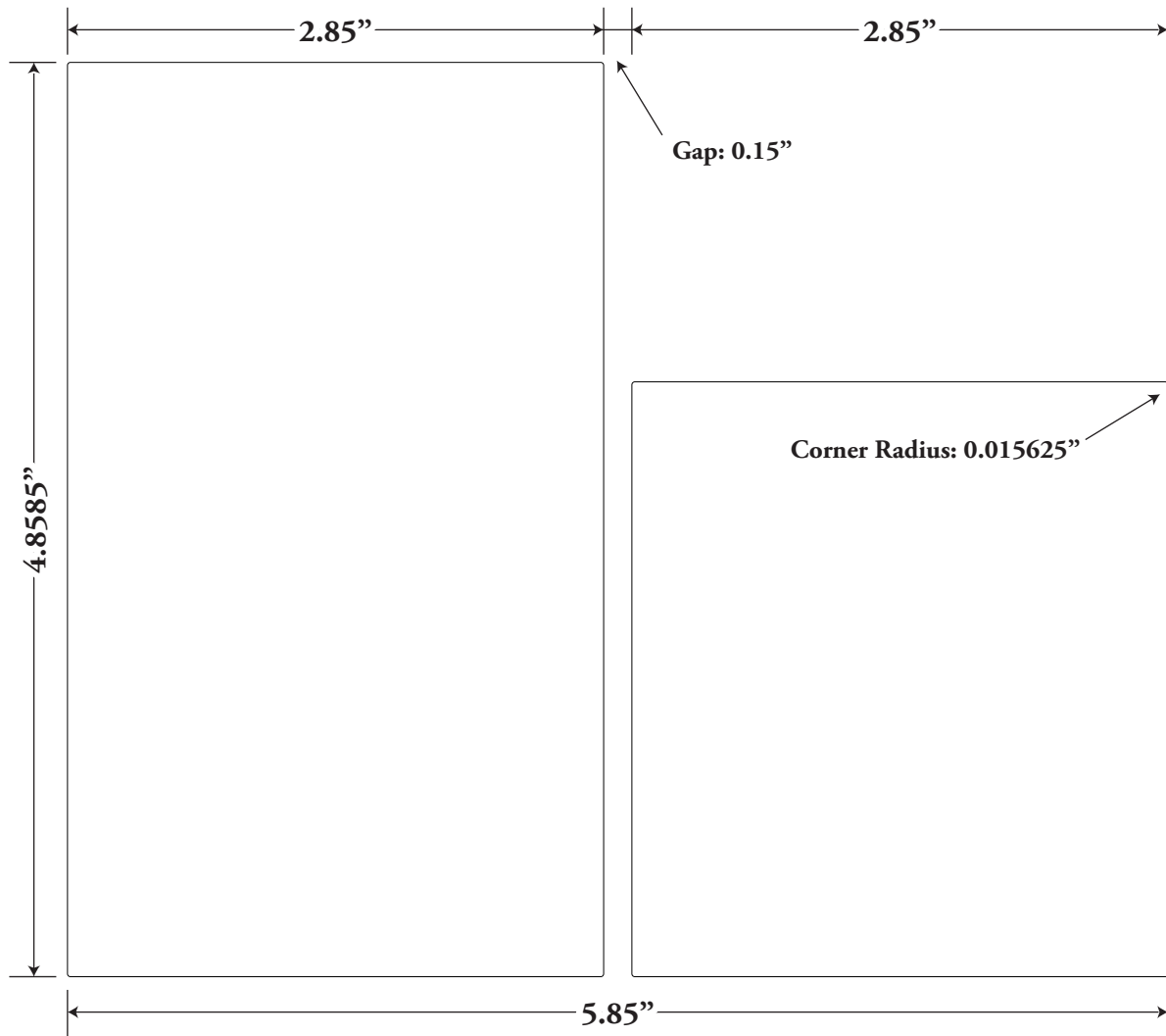

← Run Direction →

Die#: NEW
Size: 4.25" x 6.25"
Corners: .015"
Material Type: sw matte

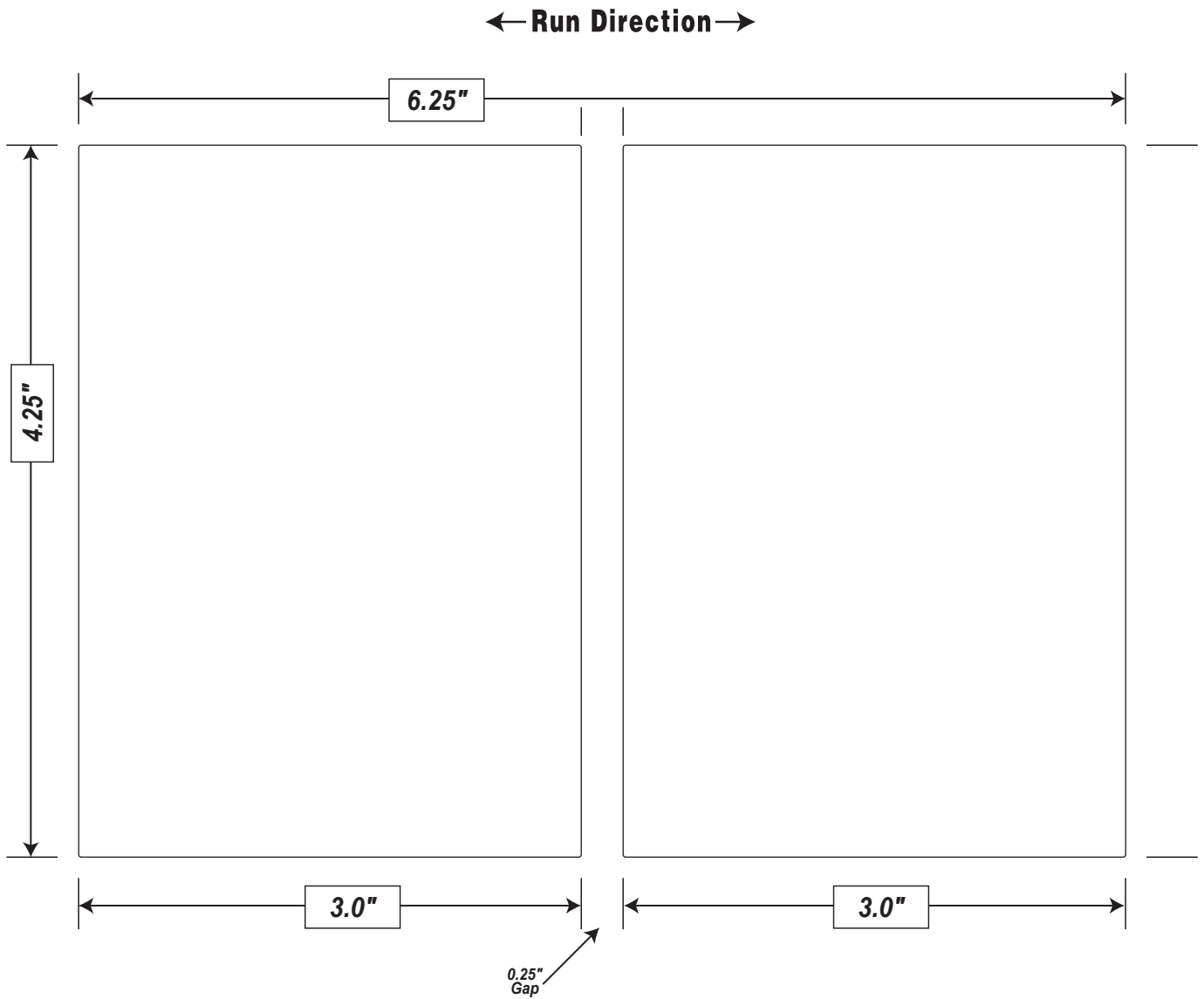

Die#/Size: V-154 3.4399" X 7.4863"
Corners: 1/64"
Material Type: Classic Felt
Varnish: Satin Coat
:

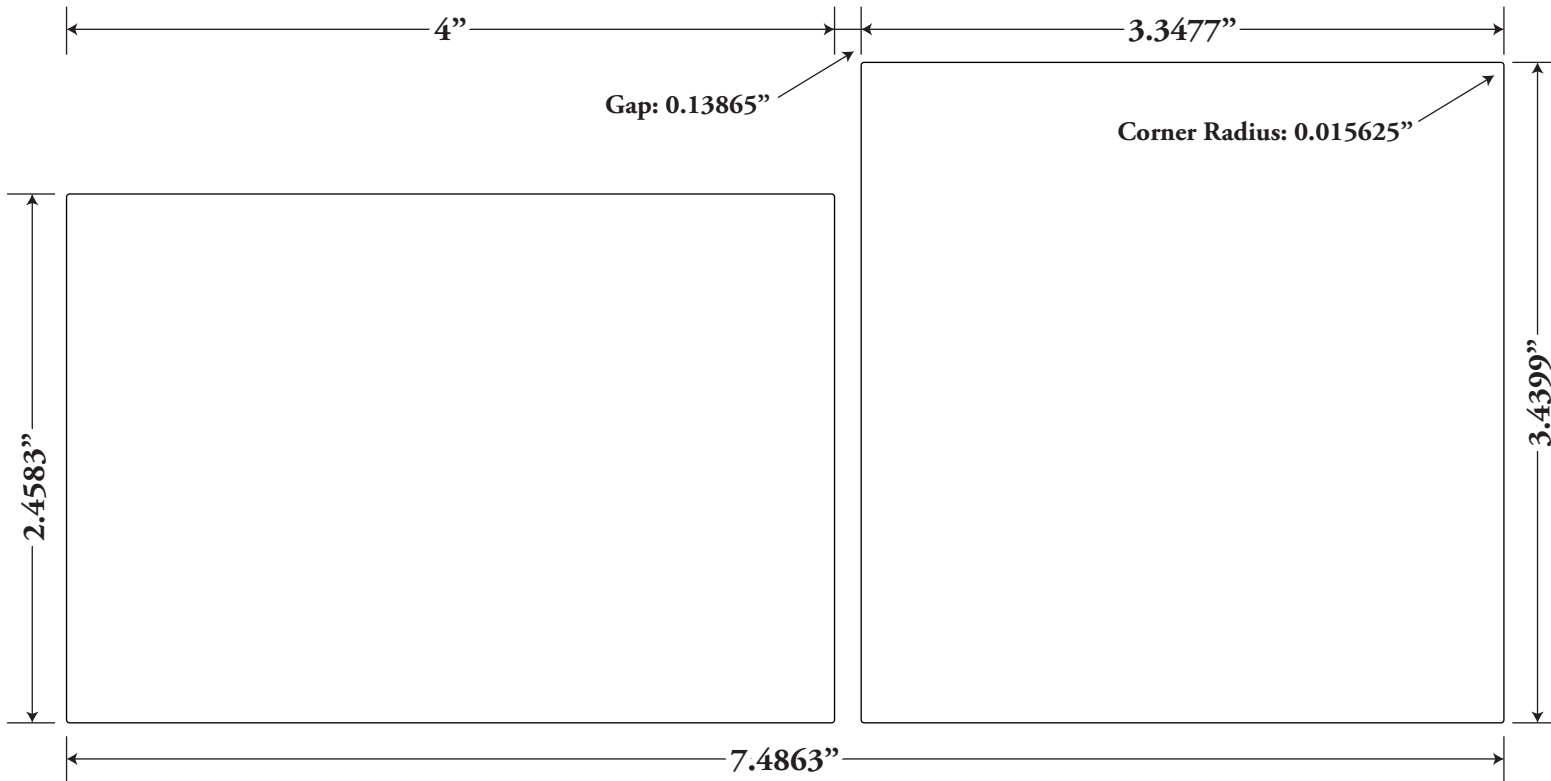

← Run Direction →

Die#: V-155
Size: 1.6231" x 8.7818"
Corners: 1/64"
Material Type: Classic Crest
Varnish: Gloss Crystal Barrier
Shape: Special

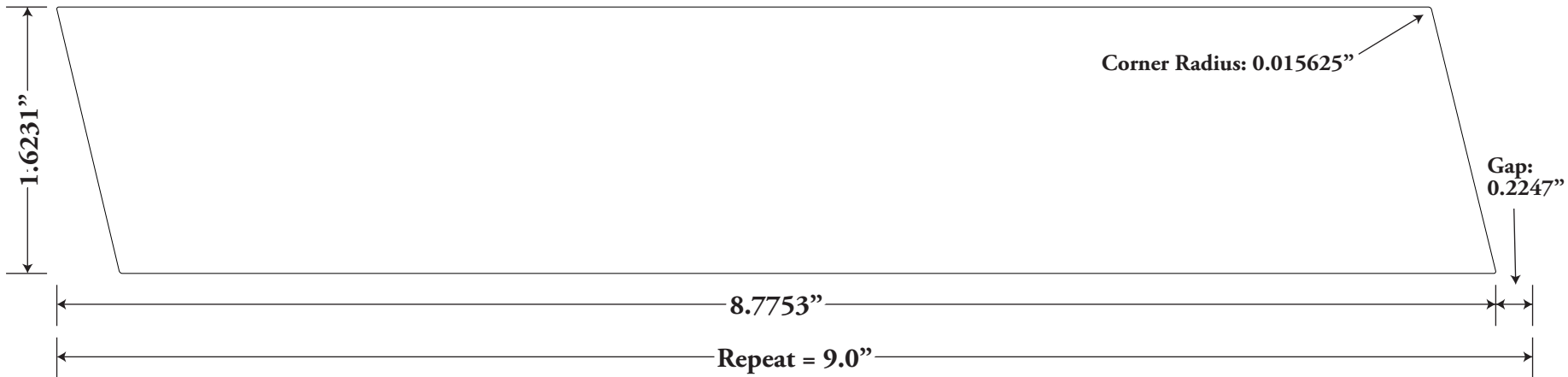

Die#: V-156
Size: 3.652" x 7.375"
Corners: .0156"
Material Type: Matte Litho
Varnish: Spot UV
Laminate: none
Special tooling: None

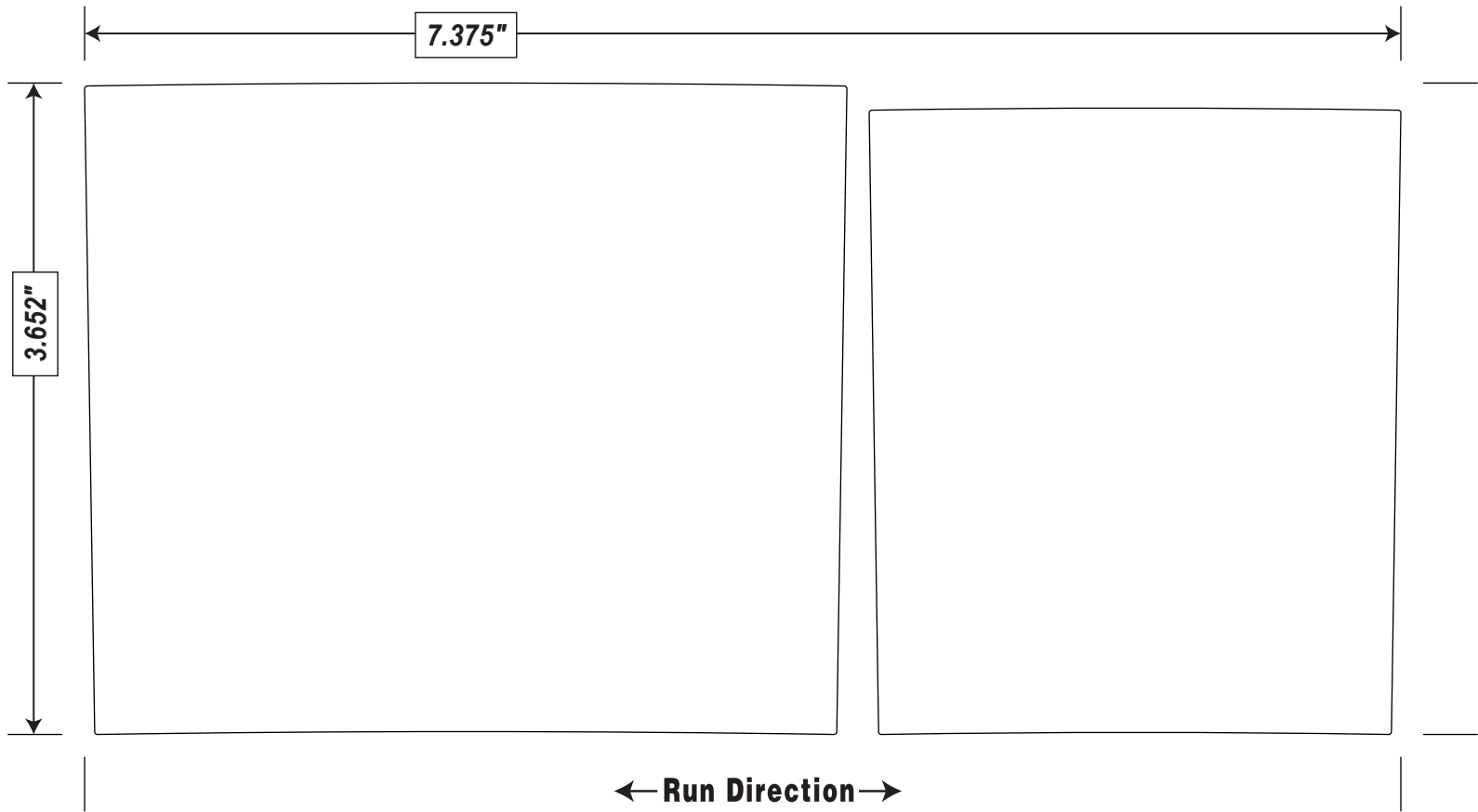

Die#: NEW
Size: 3.7012" x 7.2056"
Corners: Special
Material Type: 2 ML White Bopp
Varnish: Pearlescent UV

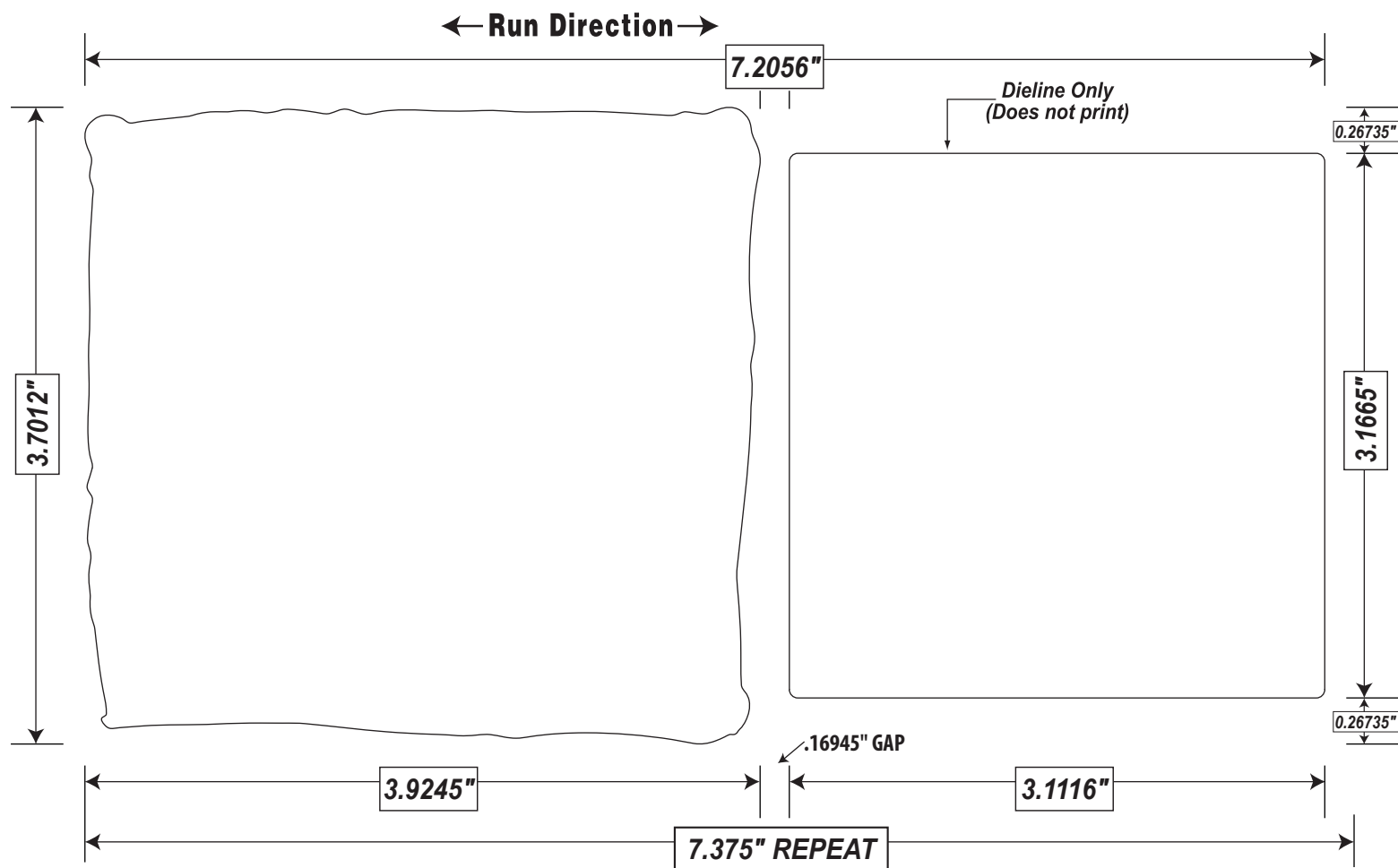

Die#: V-168
Size: 2.75" x 7.5625"
Corners: 1/64"
Material Type: Classic Crest
Varnish: Matte
Laminate: None
Special tooling: Sculpted Emboss

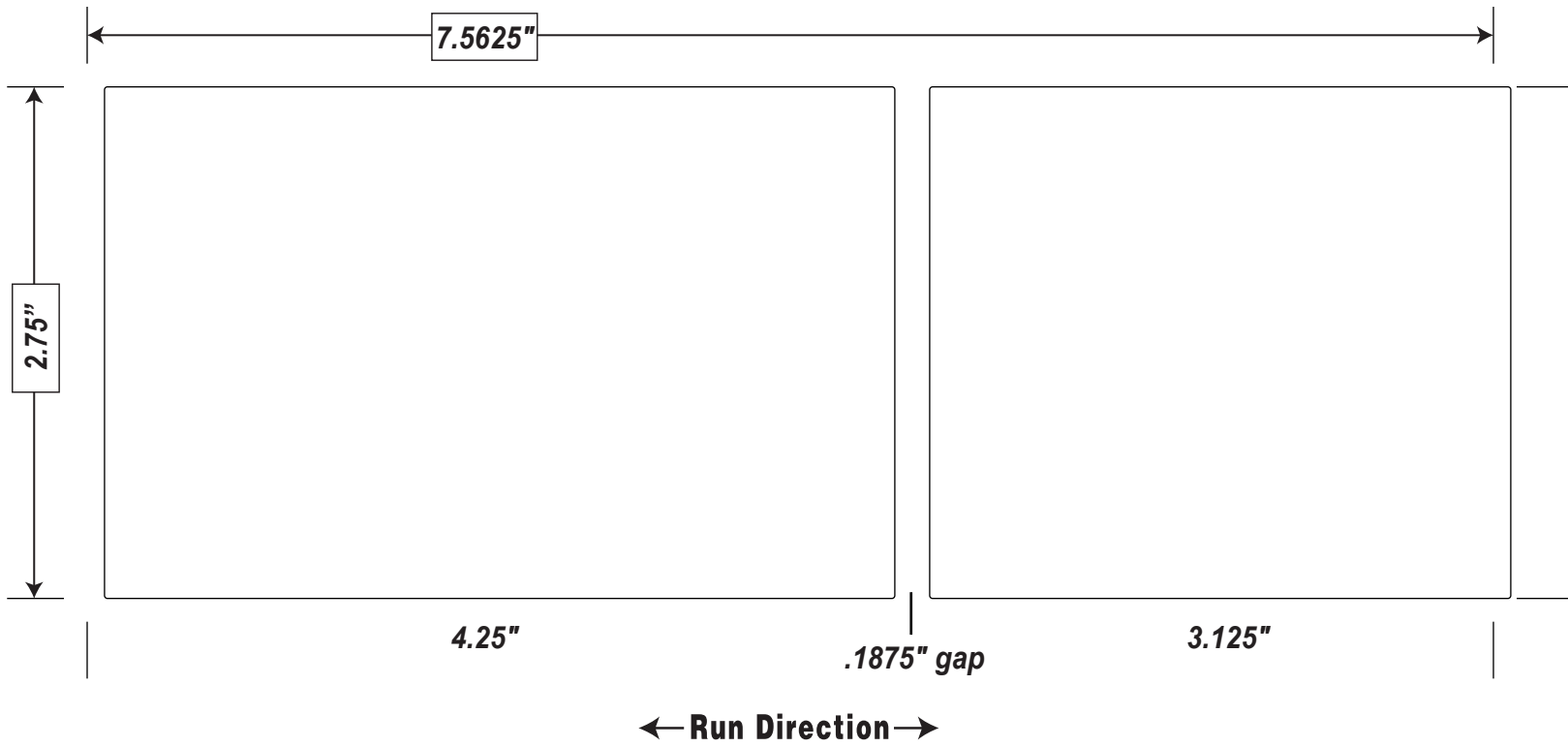

Die#: V-170
Size: 2.91" X 8.59"
Corners: 1/64"
Material Type: Eggshell Felt
Varnish: yes - satin coat 2
Laminate: none
Special tooling: none

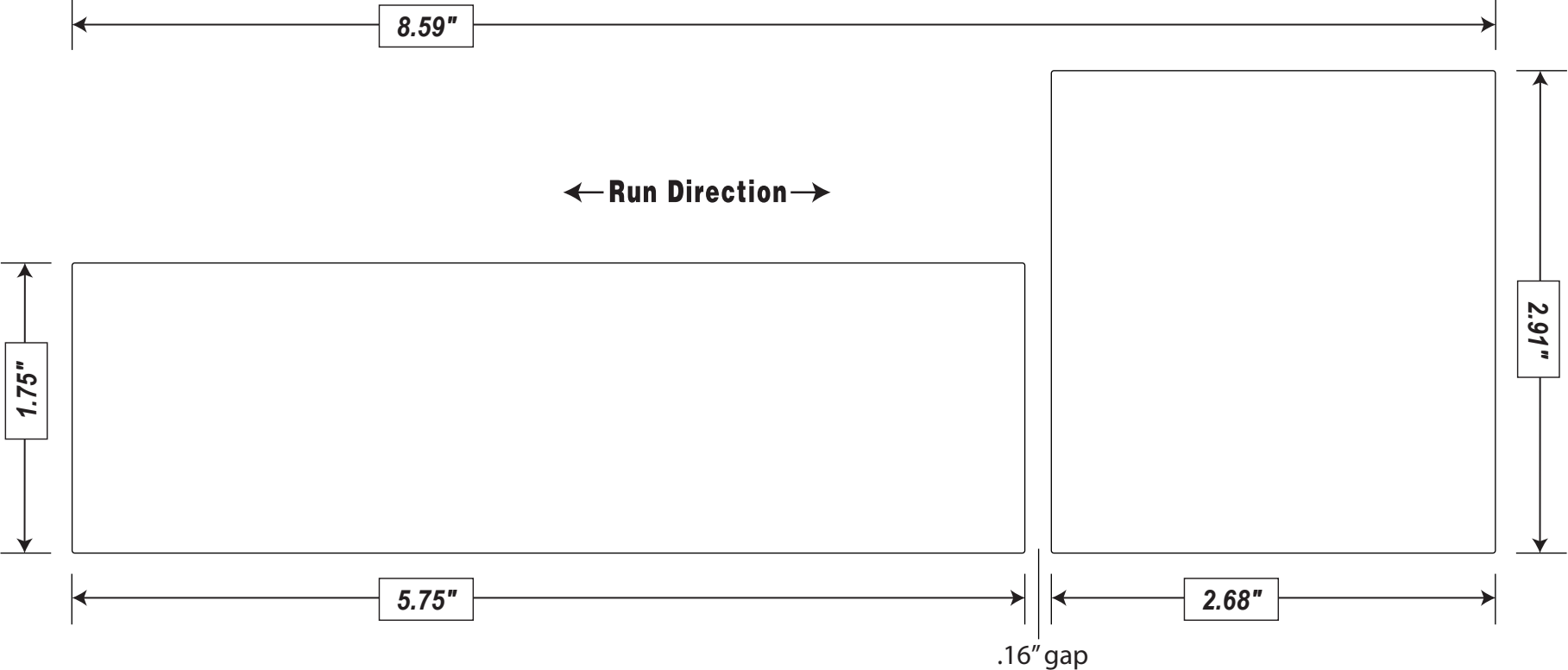

Die#/Size: V-191 4 x 6.375
Corners: .015625
Material Type: Classic Felt
Varnish: ?
Laminate: no
Special tooling: no

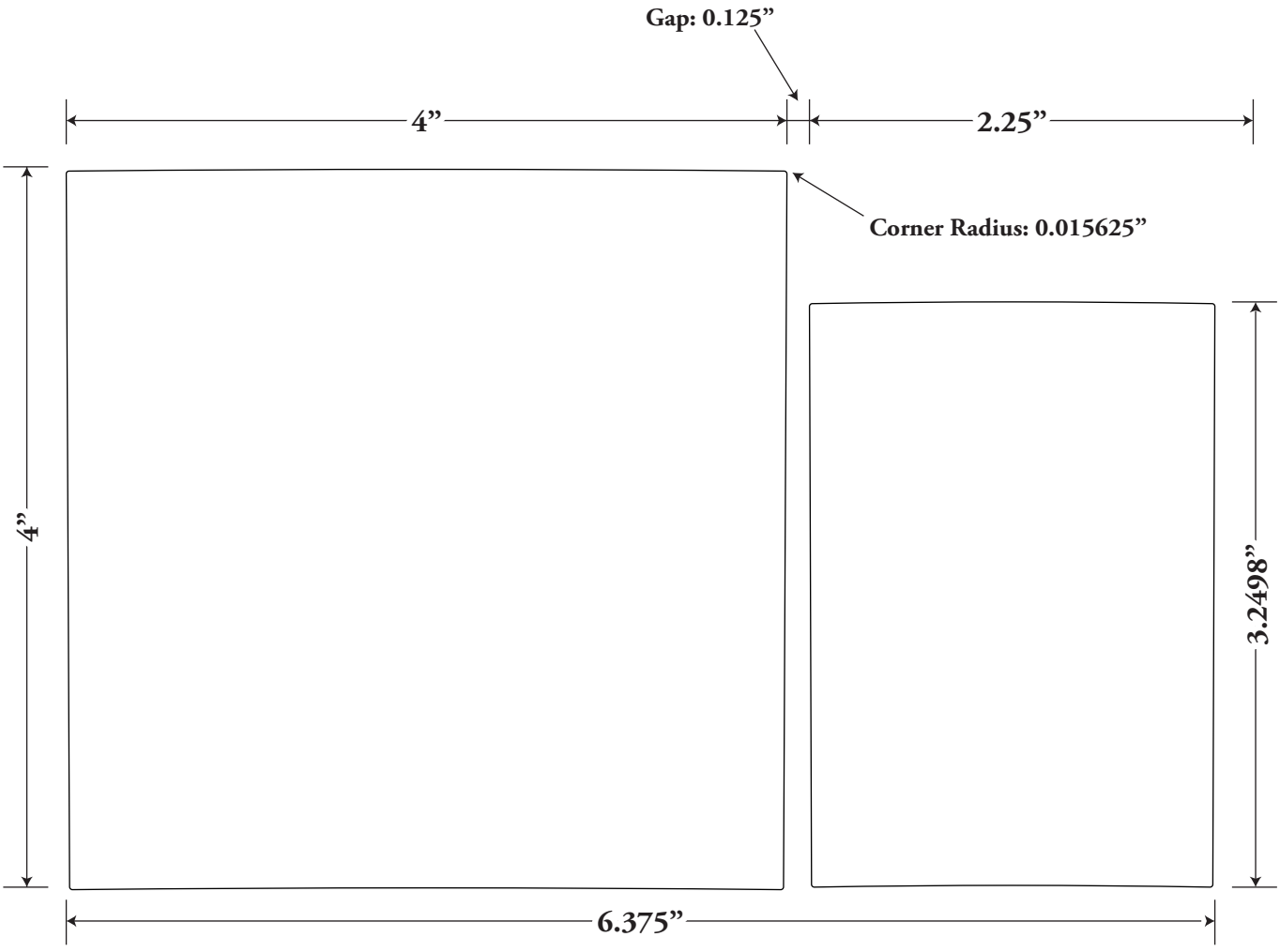

Die#/Size: V-193: 3.75" X 6.125"
Corners: 1/64"
Material Type: Classic Crest
Varnish: Matte Crystal Barrier
Laminate: None
Special tooling: None

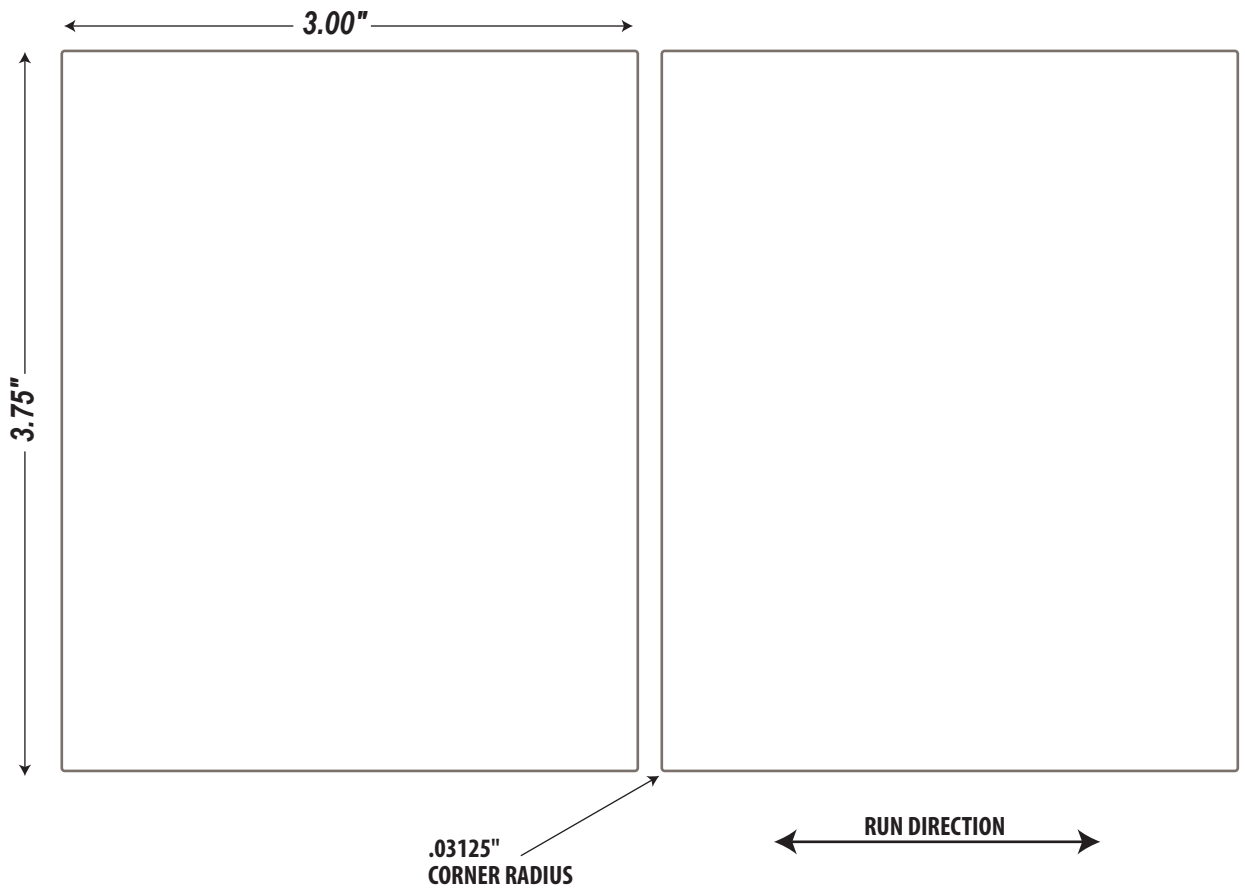

Die#: V-199
Size: 5" x 5.125"
Corners: 1/64"
Material Type: CLASSIC CREST
Varnish: GLOSS UV
Laminate: NONE
Special tooling: NONE

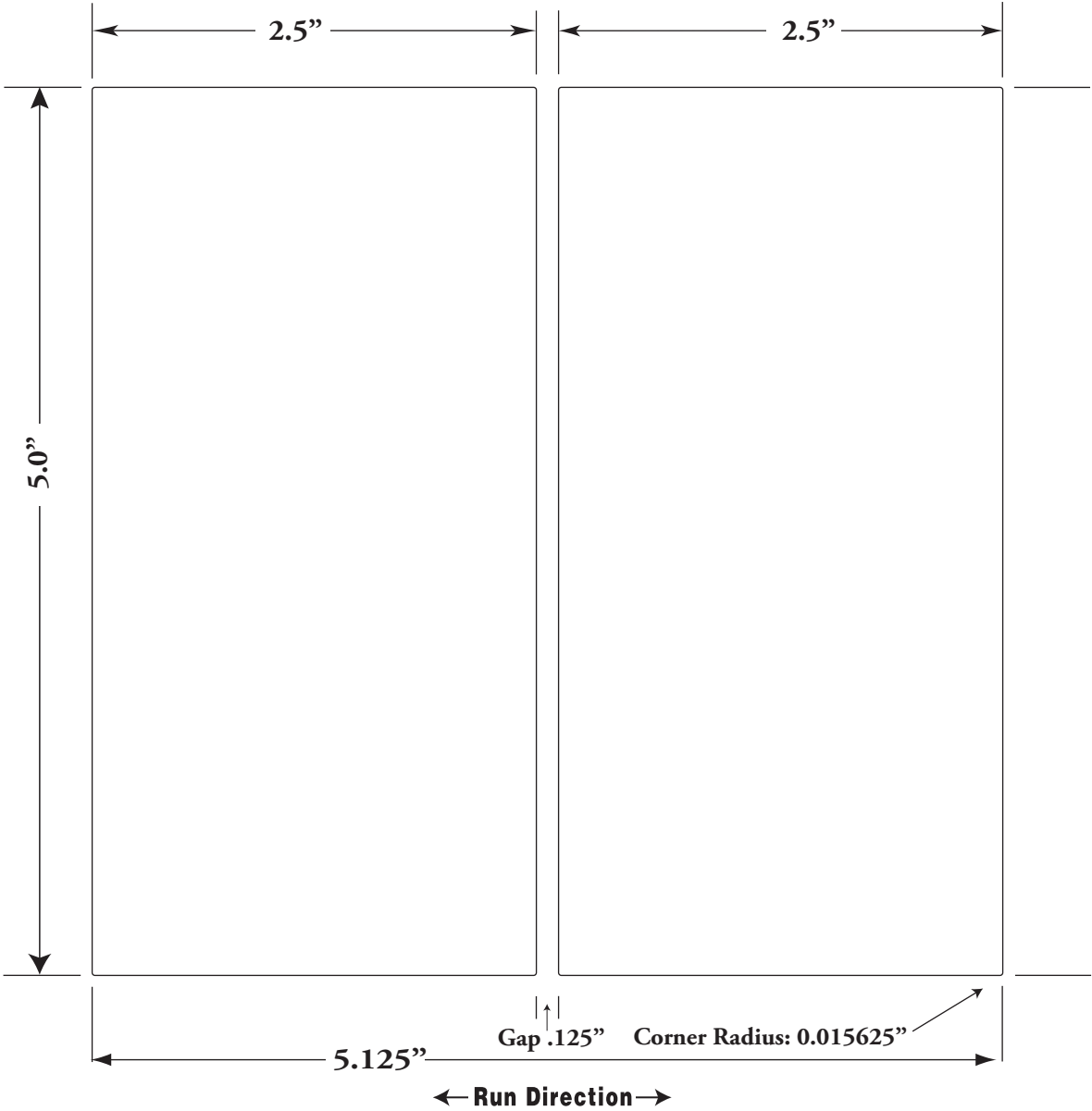

Die#: V-200
Size: 4" x 8.125"
Corners: 1/64"
Material Type: CLASSIC CREST
Varnish: GLOSS
Laminate: NONE
Special tooling: NONE

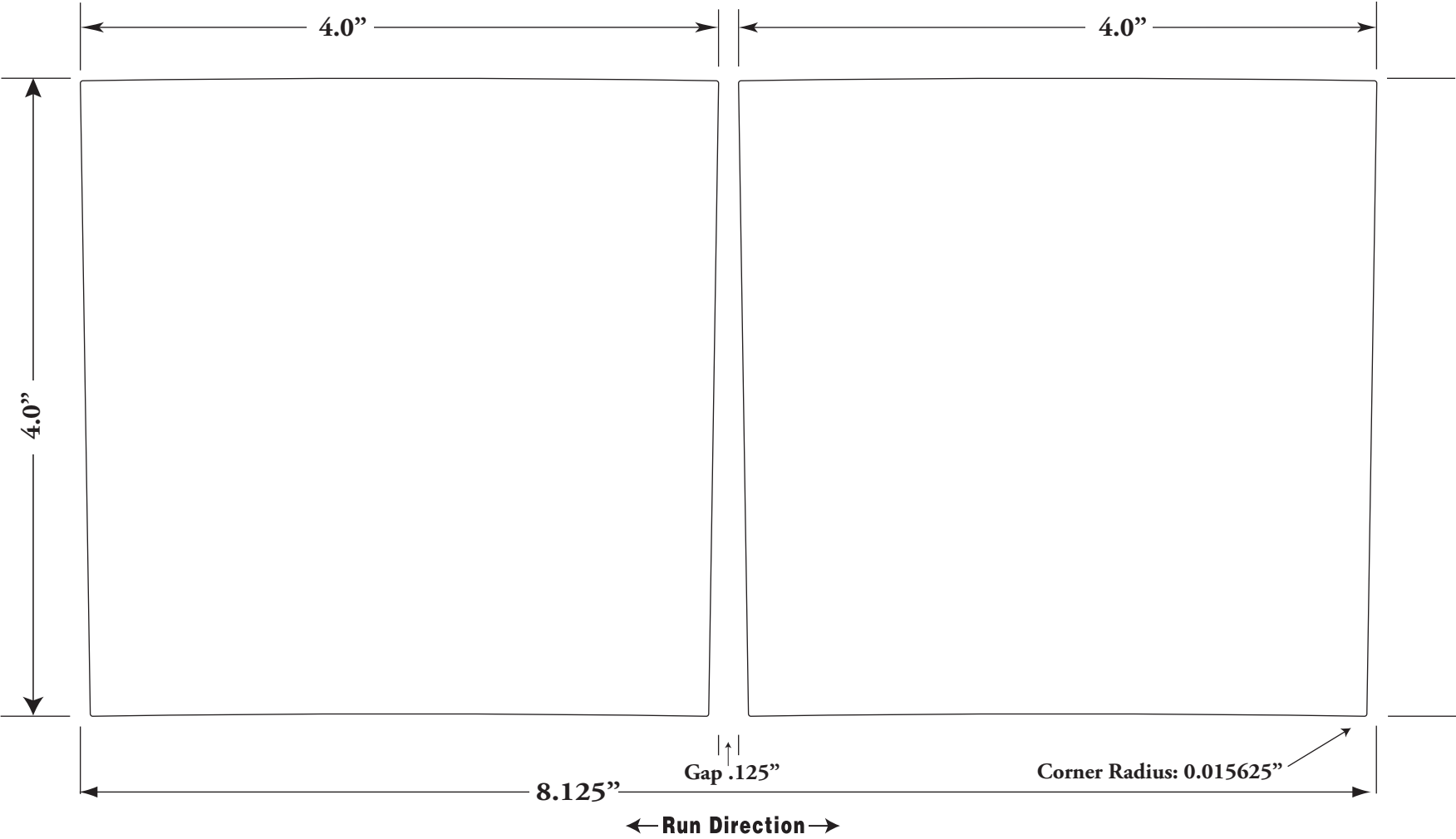

Die#: V-203

Size: 5.75" x 5.625"

Corners: 1/64"

Material Type: Classec Felt

Varnish: Gloss Crystal Barrier

Laminate: none

Special tooling: none

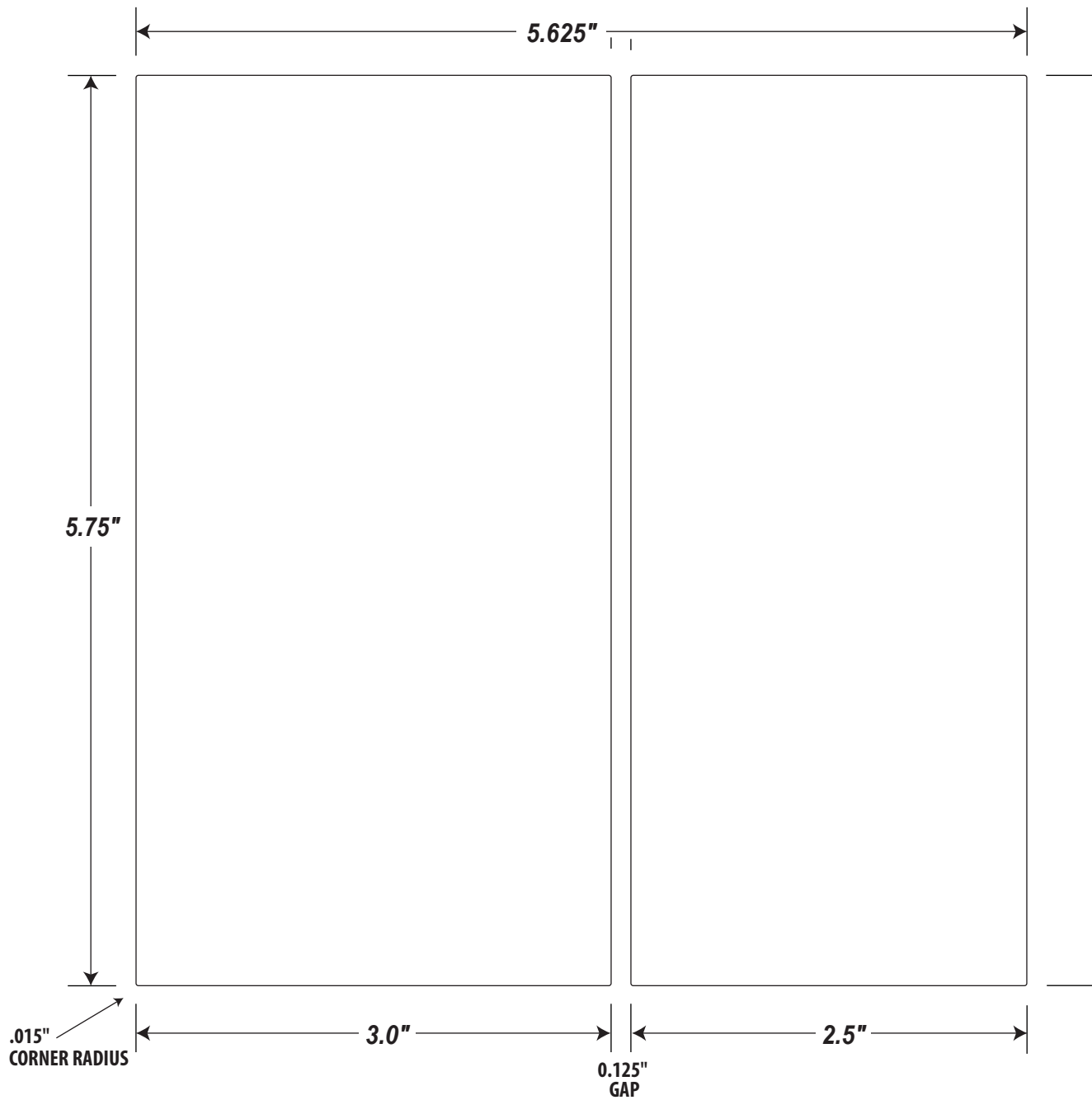

Die#: V-204
Size: 4" x 6.375"
Corners: 1/64"
Material Type: Classec Felt
Varnish: Gloss Crystal Barrier
Laminate: none
Special tooling: none

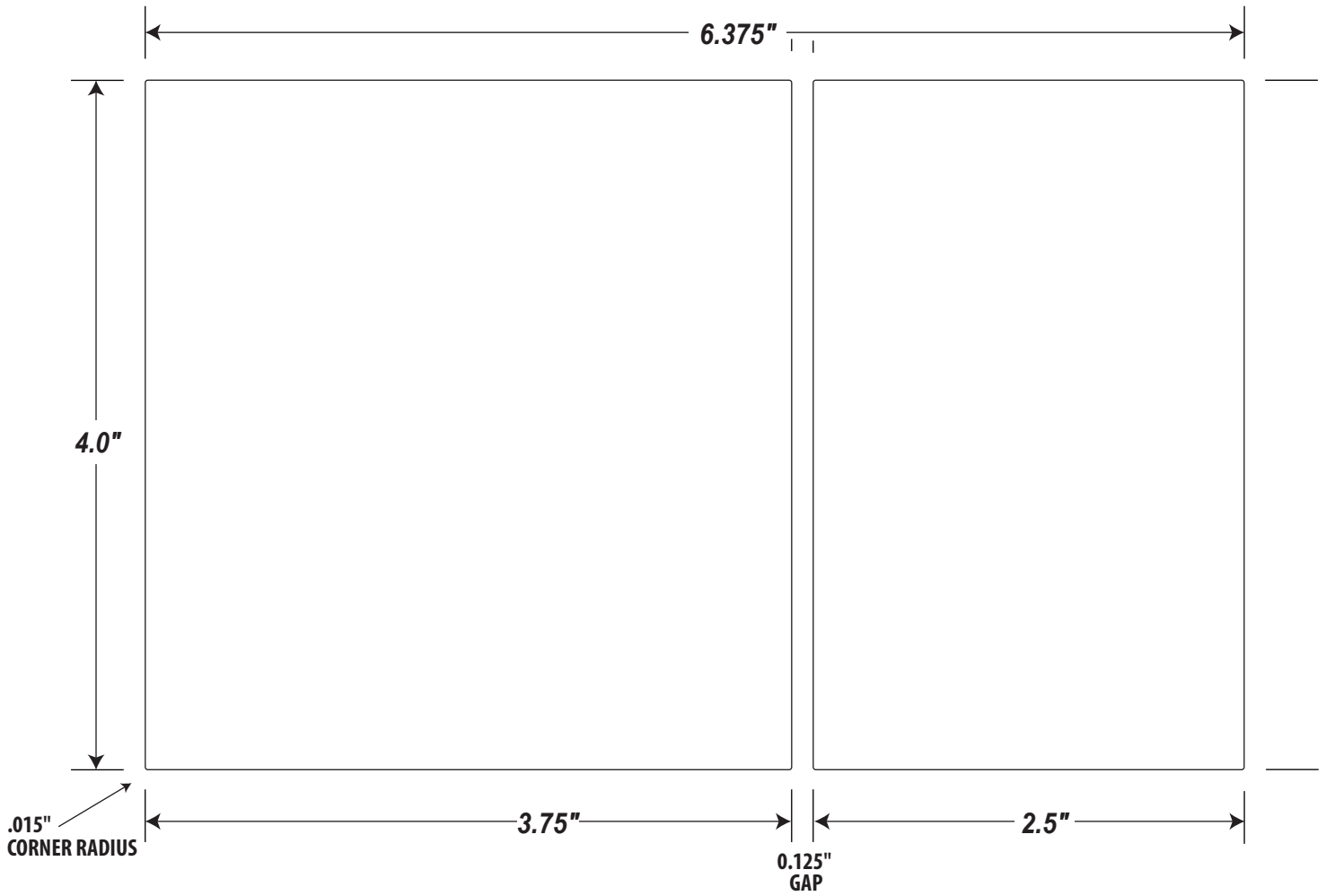

DIE# V-206
SIZE: 5.8 x 3.125 "
CORNERS: 0.0156 "
MATERIAL TYPE: Clear Bopp
VARNISH: none
LAMINATE: no
SPECIAL TOOLING: die

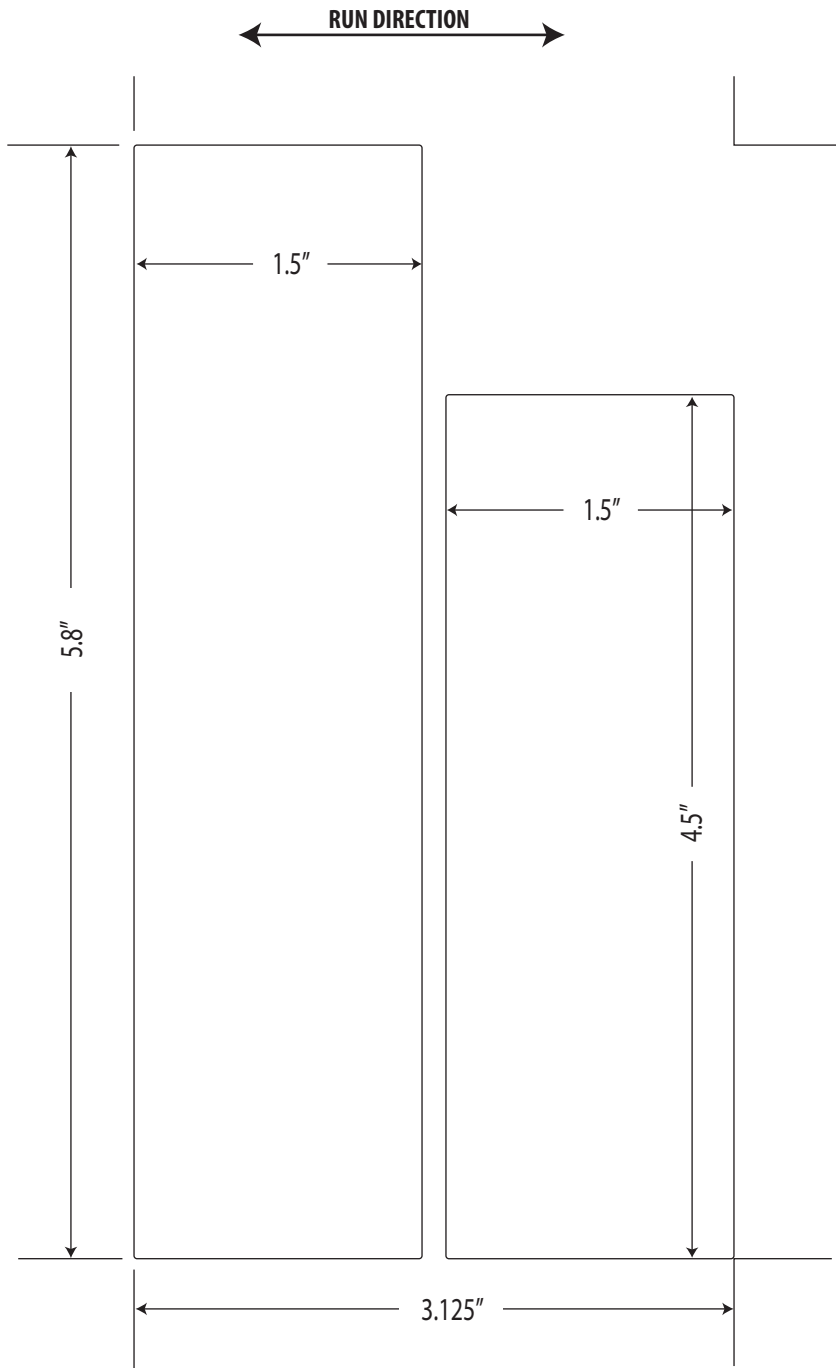

Die#/Size: V-208 4.5" x 6.375"
Corners: 1/64" (0.015)
Material Type: Estate #4
Varnish: matte varn
Laminate: None
Special tooling: None

← **Run Direction** →

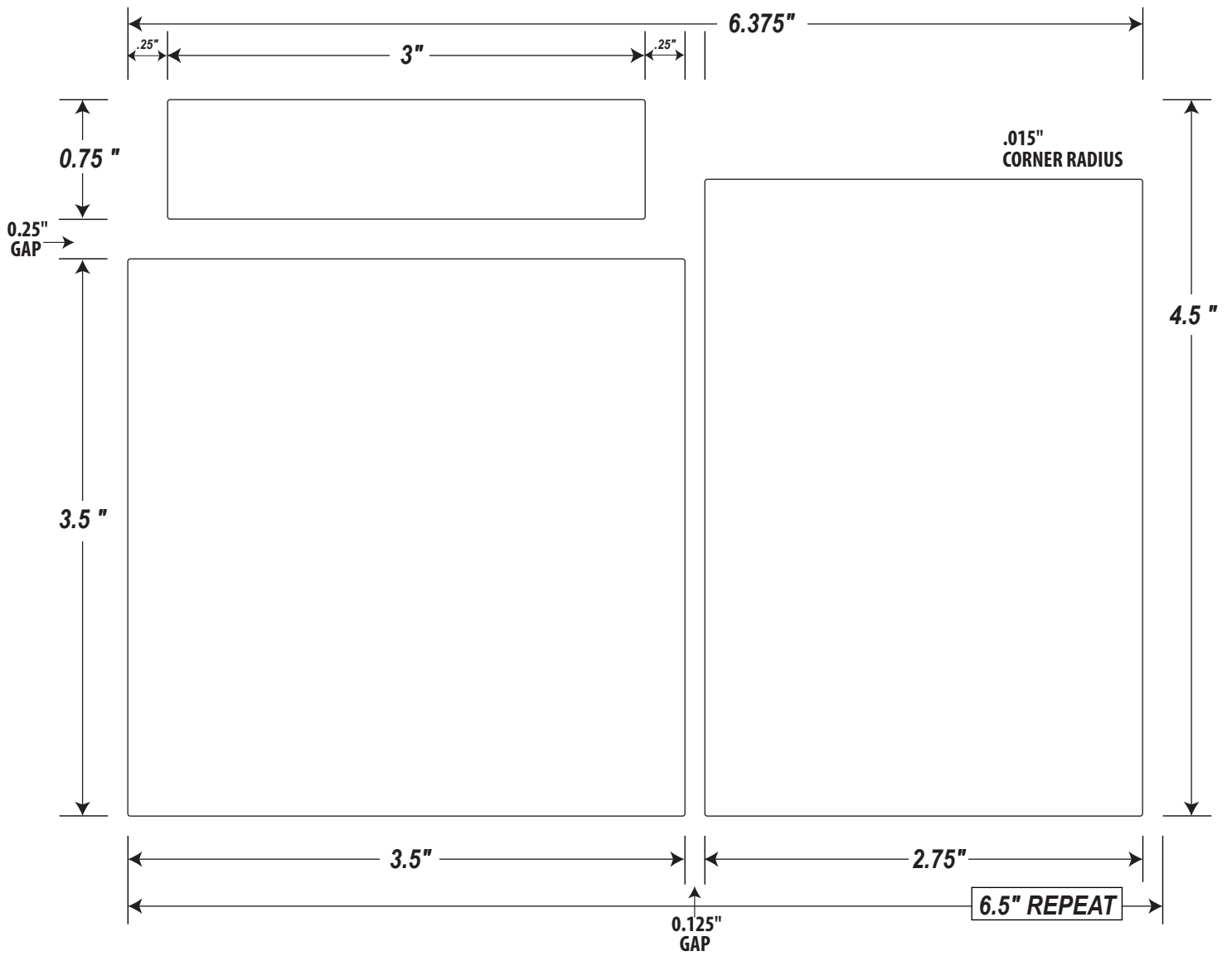

Die#: V-211
Size: 3.8343" x 8.68"
Corners: n/a - special shape
Material Type: Estate #8
Varnish: matte crystal barrier
Laminate: none
Special tooling: none

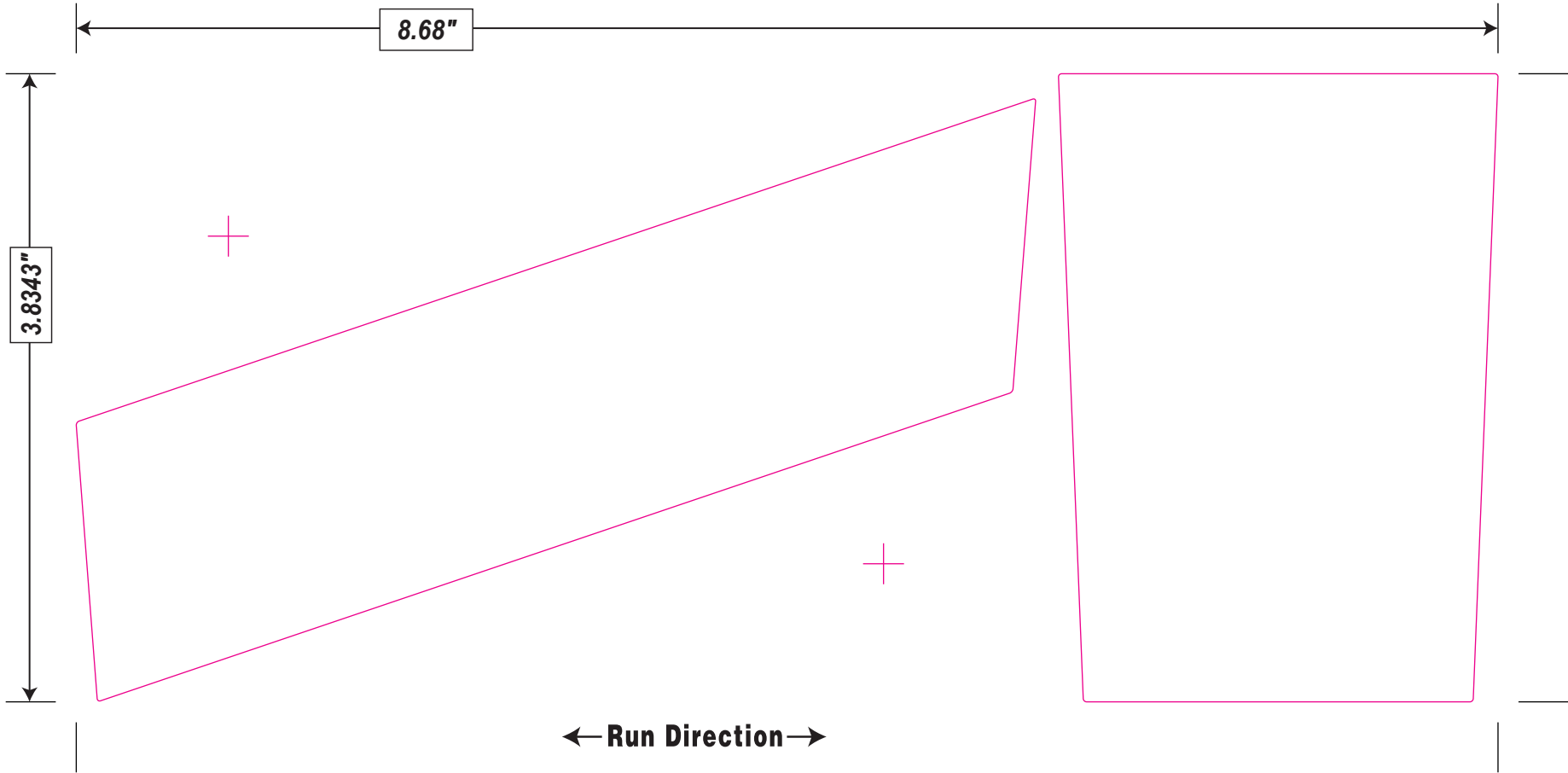

Die#:V-213
Size: 4.125" x 5.25"
Corners: 0.015"
Material Type: Classic Crest
Varnish: TBD
Laminate:
Special tooling:

← Run Direction →

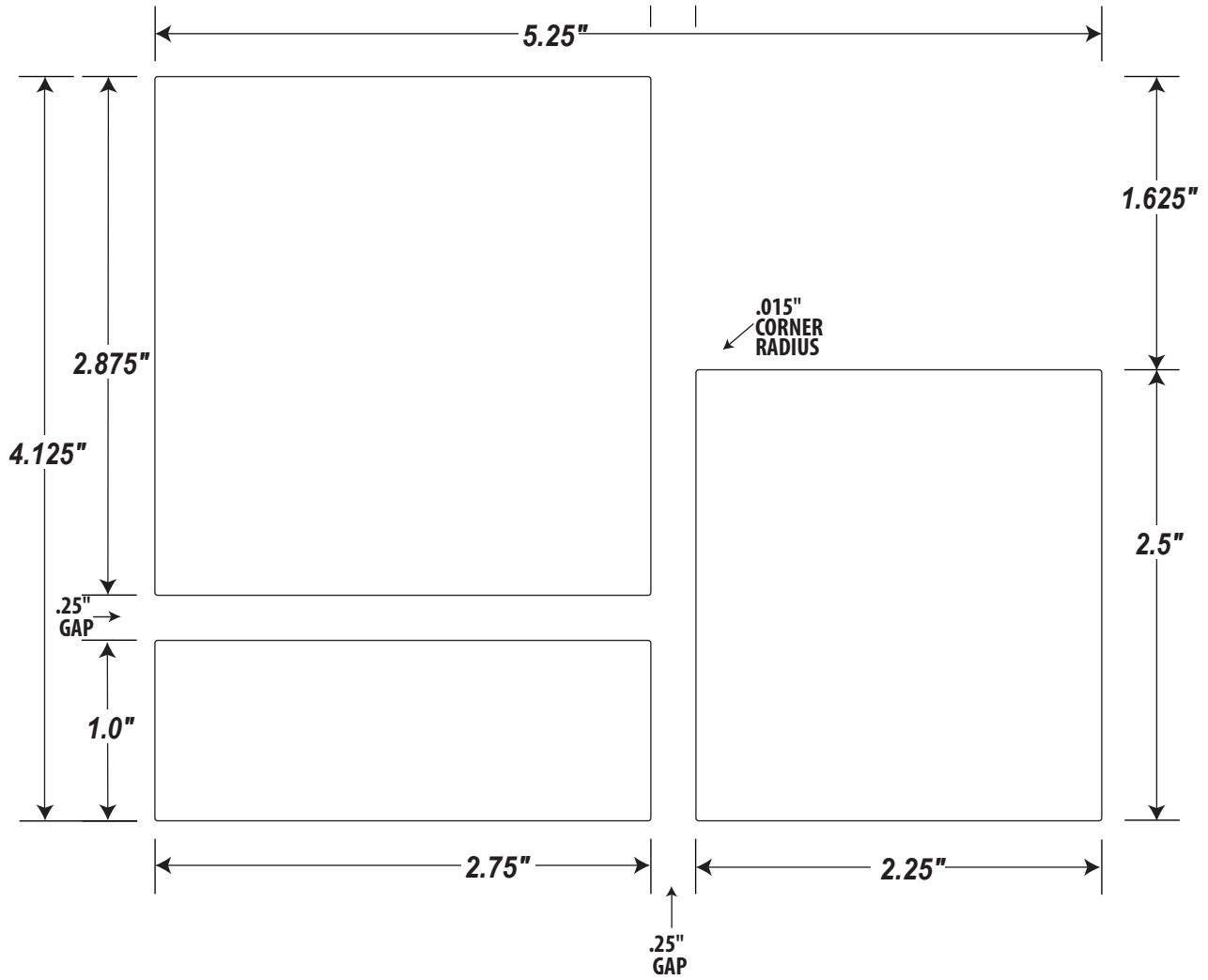

DIE# V-216
SIZE: 2.25" X 3.5"
CORNERS: 0.125"
MATERIAL TYPE: Classic Crest
VARNISH: Matte Crystal
LAMINATE: none
SPECIAL TOOLING: none

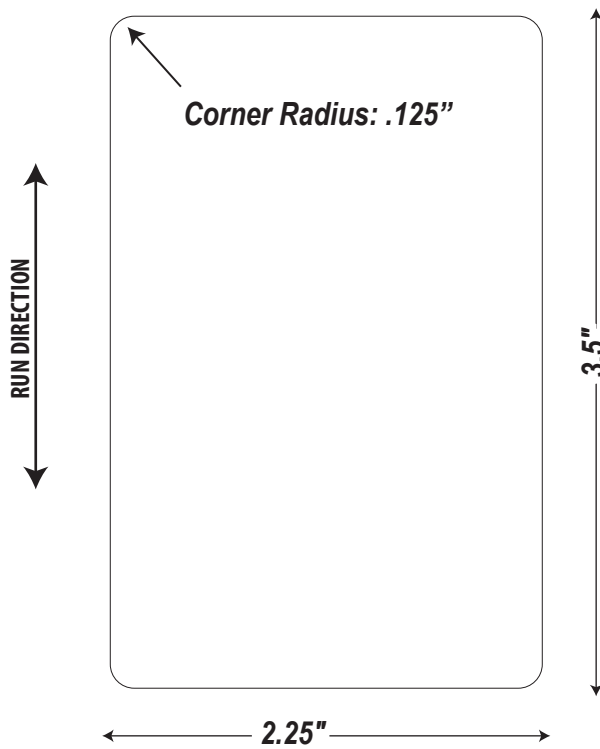

Die#: V-217
Size: 4.95" x 6.0"
Corners: 0.015"
Material Type: Classic Crest
Varnish: TBD
Laminate:
Special tooling:

← Run Direction →

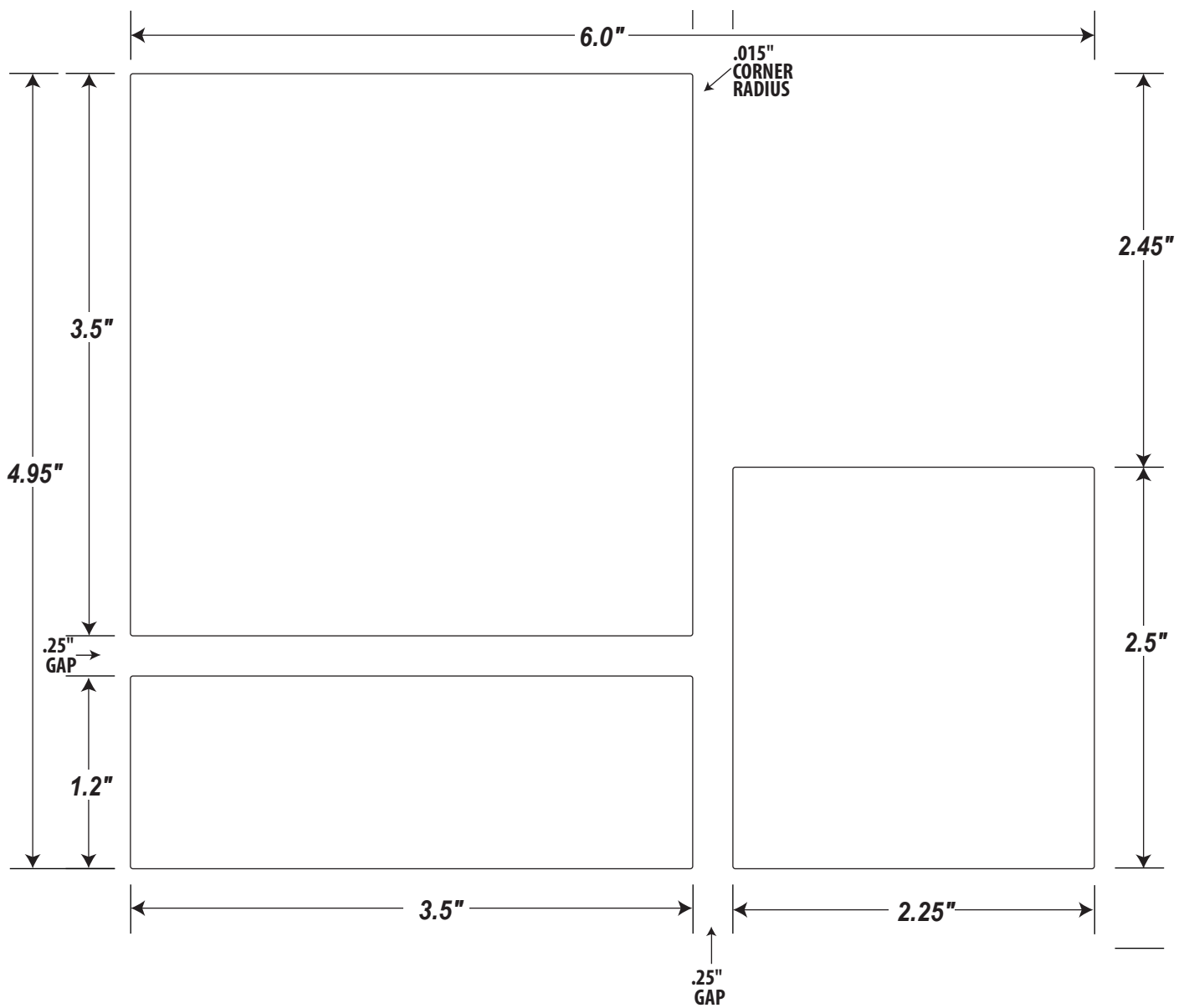

Die#/Size: V-218 3.9375" x 2.0"

Corners:

Material Type: Wet Strength Matte

Varnish/Laminate: Spot UV, Matte Barrier

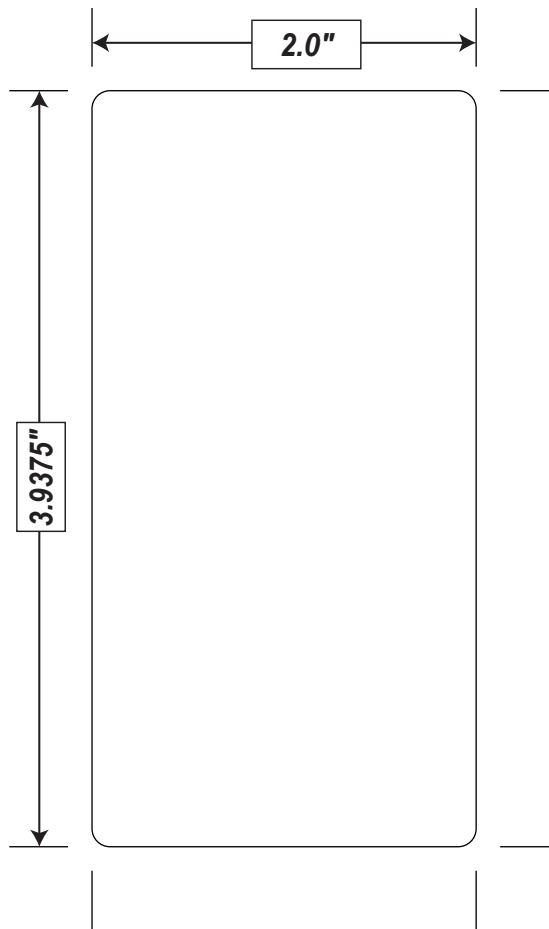

← **Run Direction** →

Die#: V-221
Size: 4" x 6.25"
Corners: .03125"
Material Type: Wine
Varnish: Spot UV
Laminate: Classic Crest Selfwound
Special tooling: Emboss

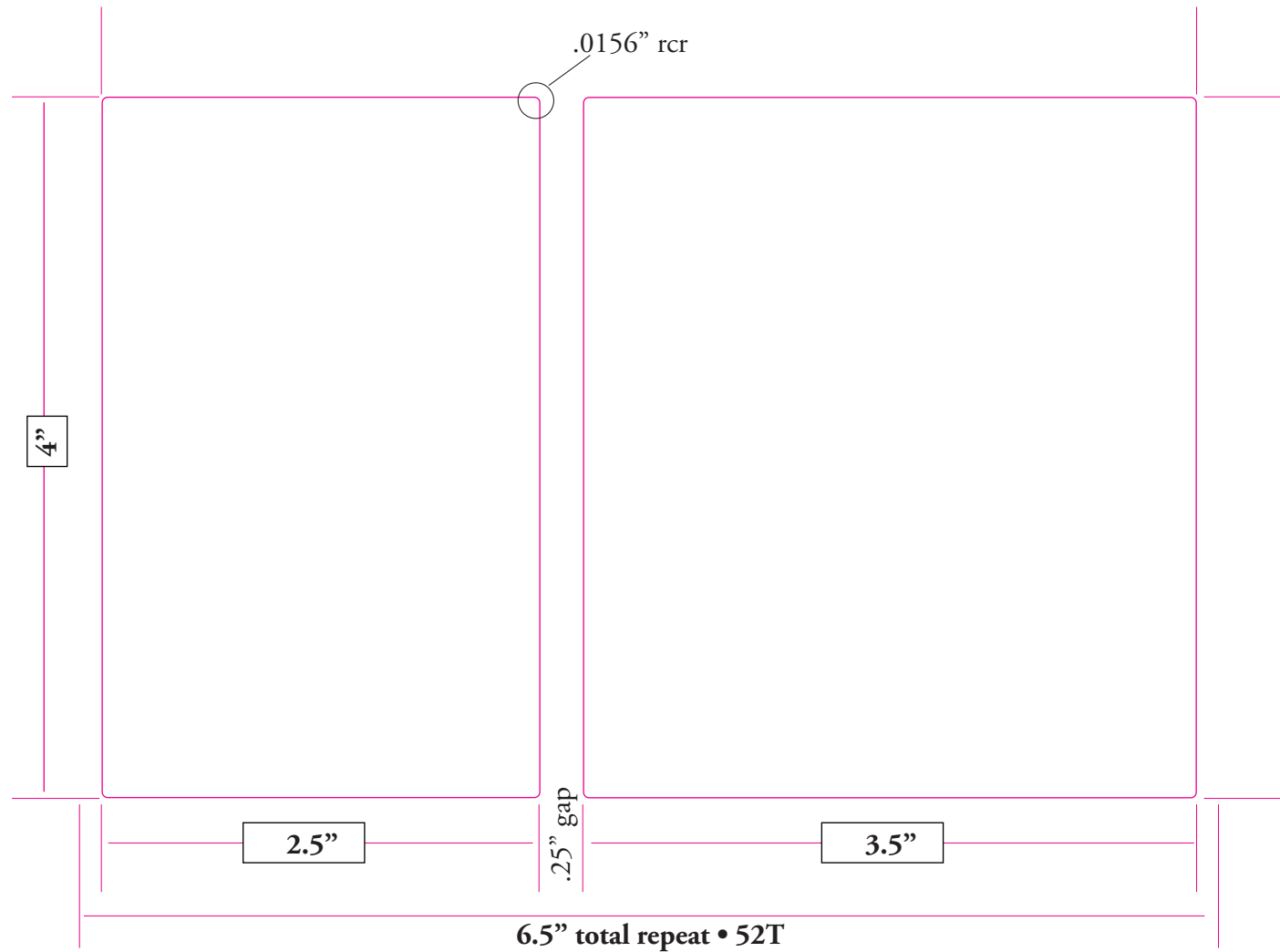

← Run Direction →

V-223 5.125" X 7"
1/64"
Classic Felt
Matte Crystal Barrier
None
Special

← Run Direction →

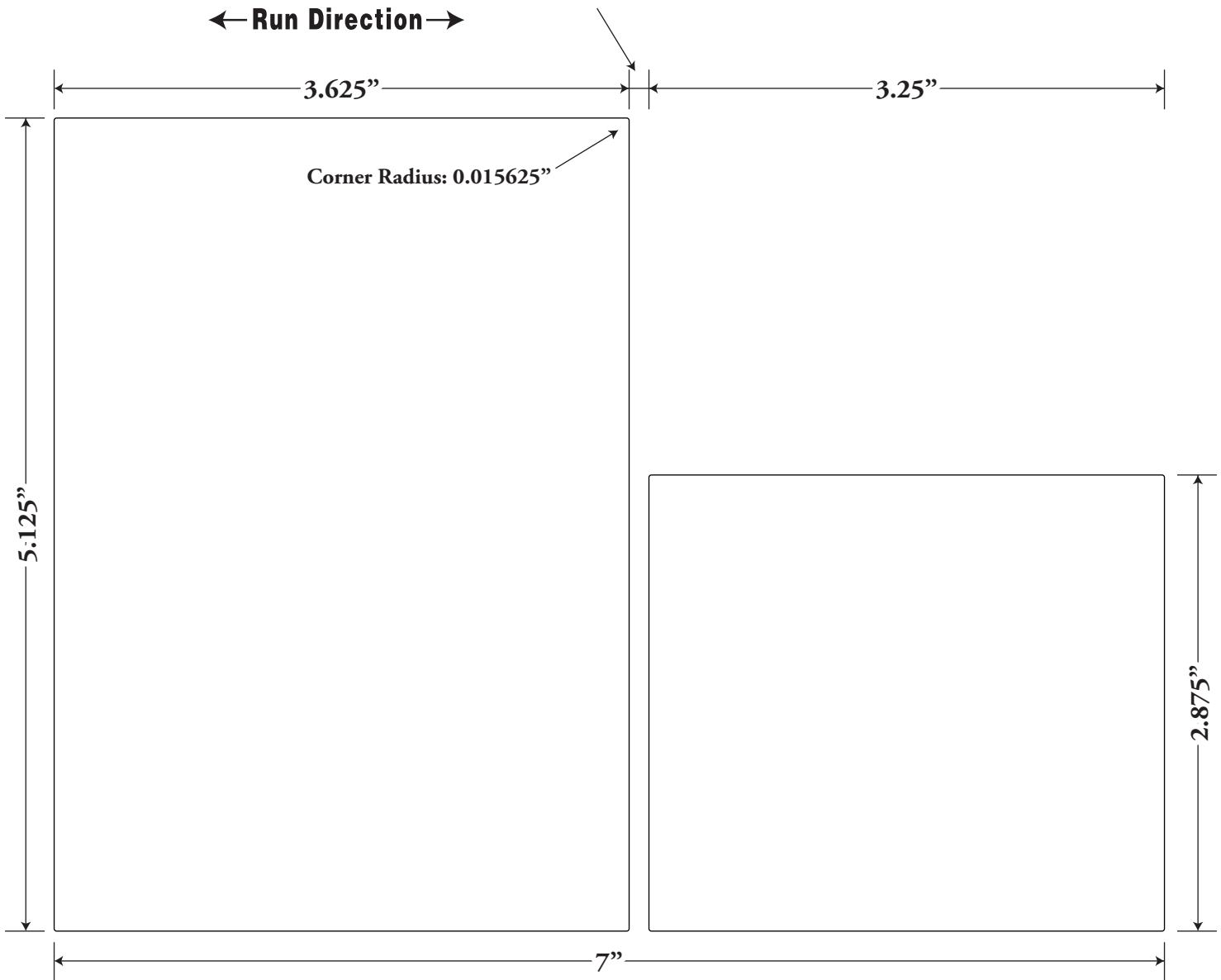

Die#: V-224

Size: 3.75" x 6.5"

Corners: 1/64"

Material Type: Bright Silver Foil

Varnish: UV

Laminate: no

Special tooling: no

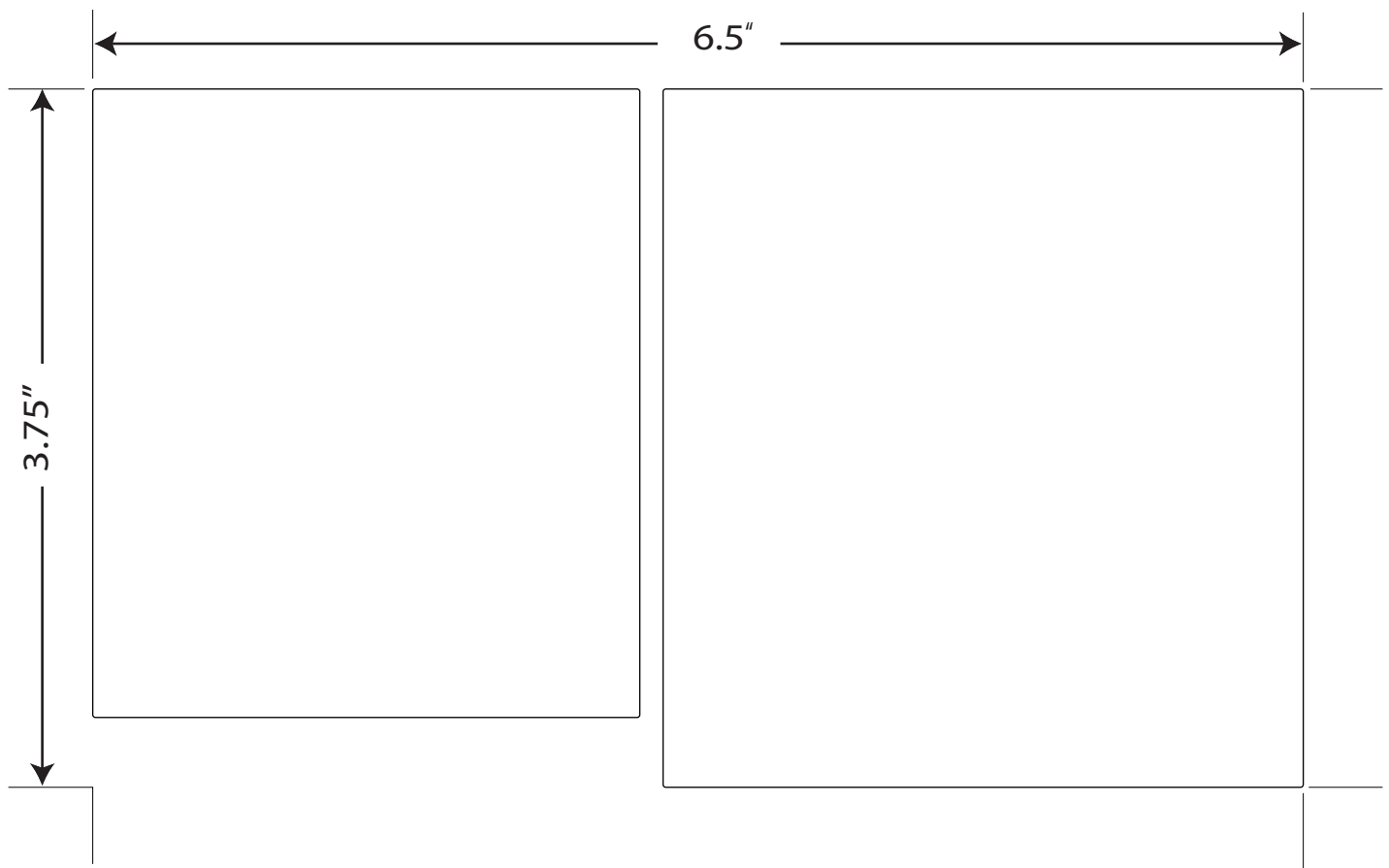

← Run Direction →

Die#: V-226
Size: 4.5" x 5.625"
Corners: .015625"
Material Type: Eggshell Felt
Varnish: none
Laminate: none
Special tooling: none

← Run Direction →

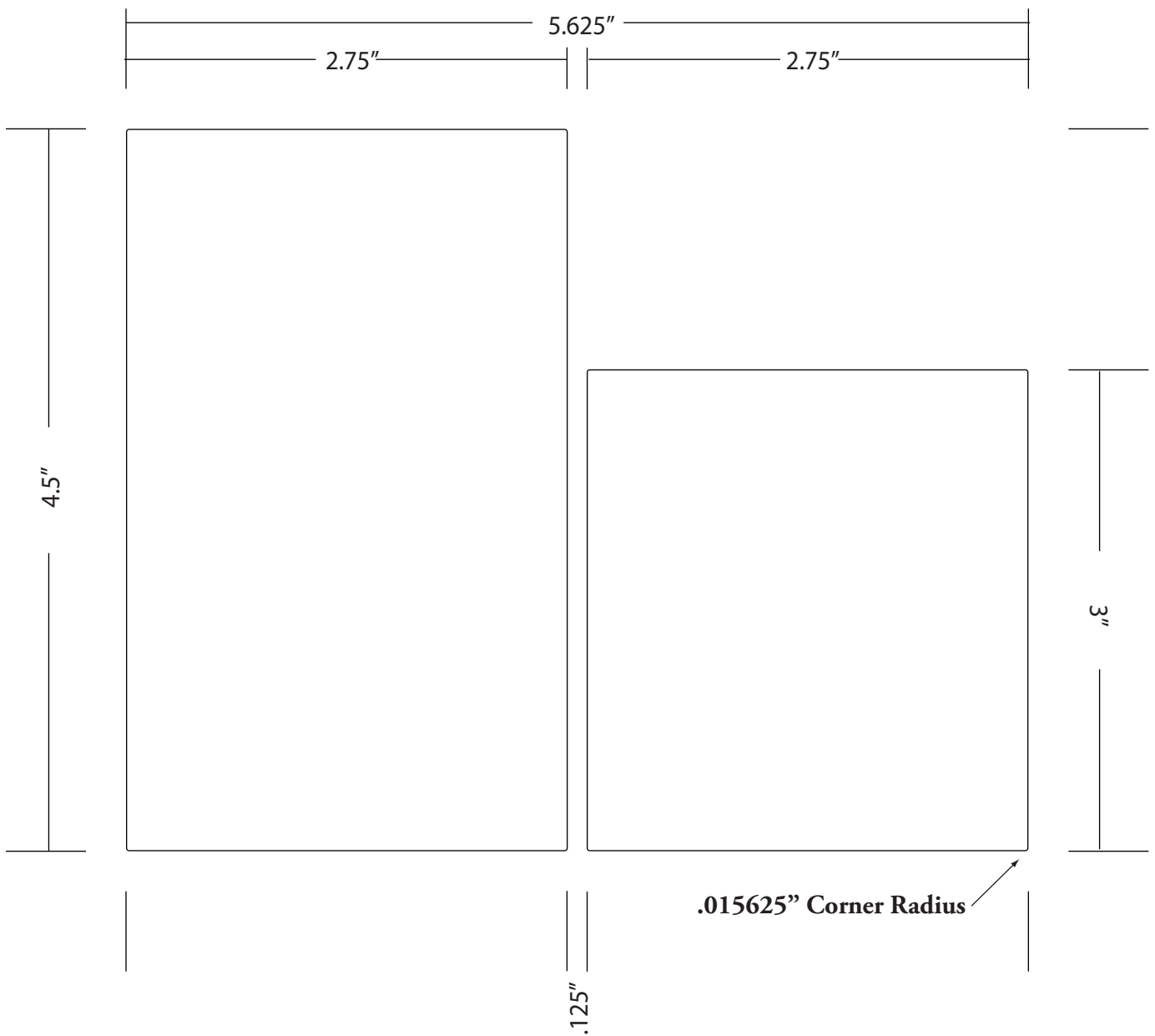

Die#: V-228
Size: 3 x 4.5"
Corners: 1/64" (.0156")
Material Type: Classic Crest
Varnish: Spot UV
Laminate:
Special tooling: new die

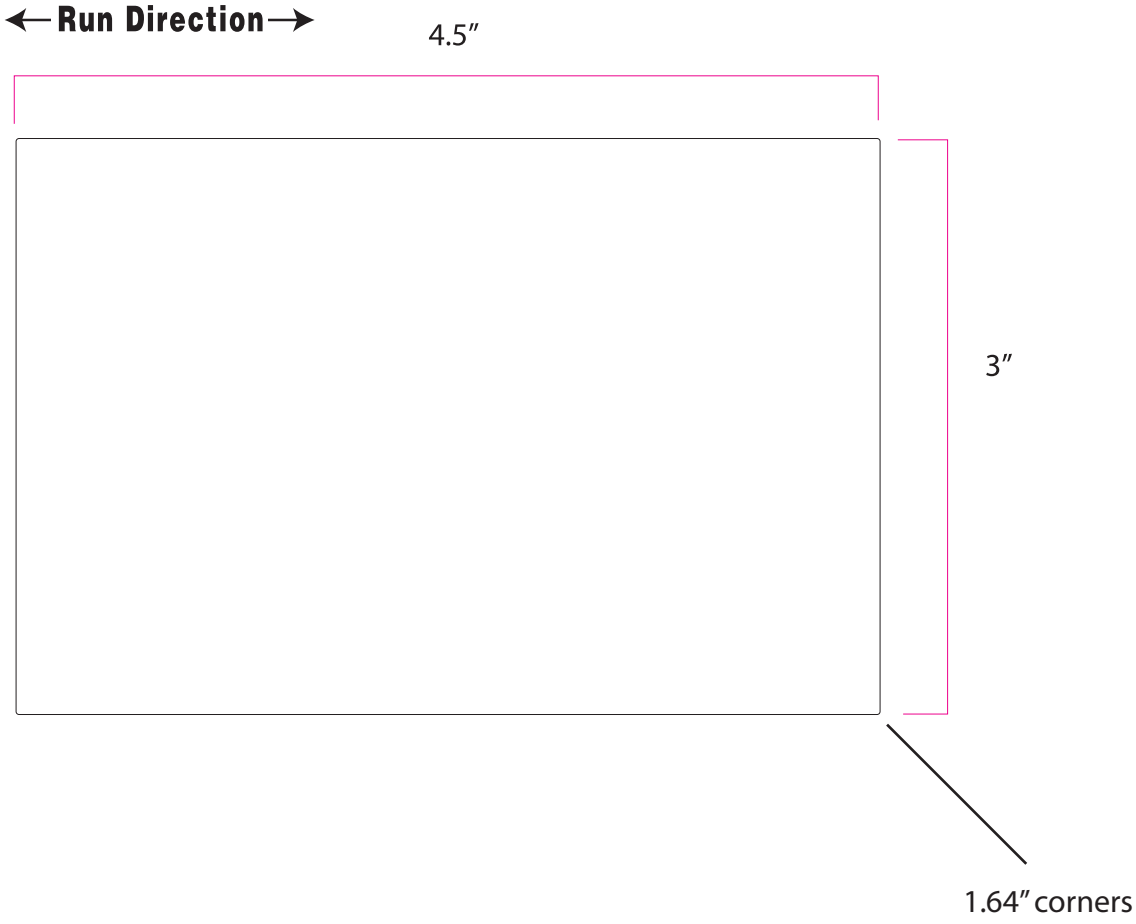

Die#: V-229
Size: 3 x 2.875"
Corners: 1/64" (.0156")
Material Type: Classic Crest
Varnish: Spot UV
Laminate:
Special tooling: new die

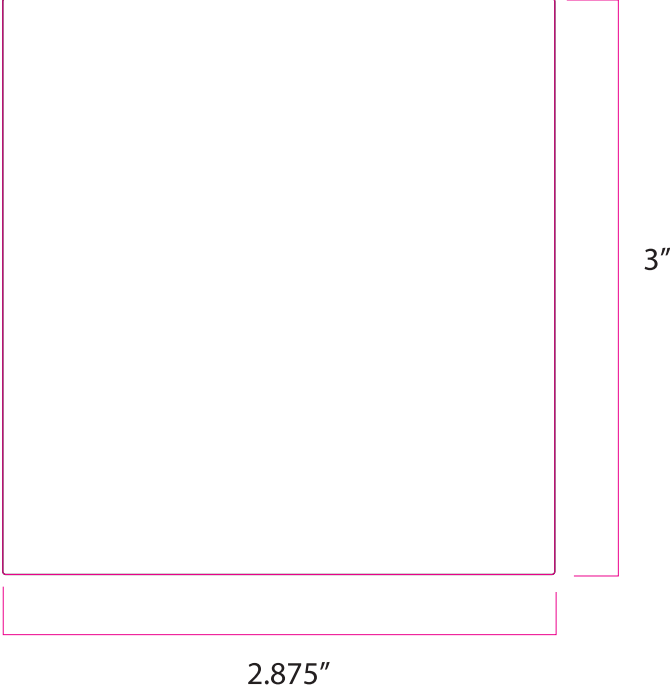

← Run Direction →

Die#: V-240
Size: 3.685" X 7.325"
Corners: 1/64"
Material Type: Classic Crest
Varnish: yes
Laminate: no
Special tooling: none

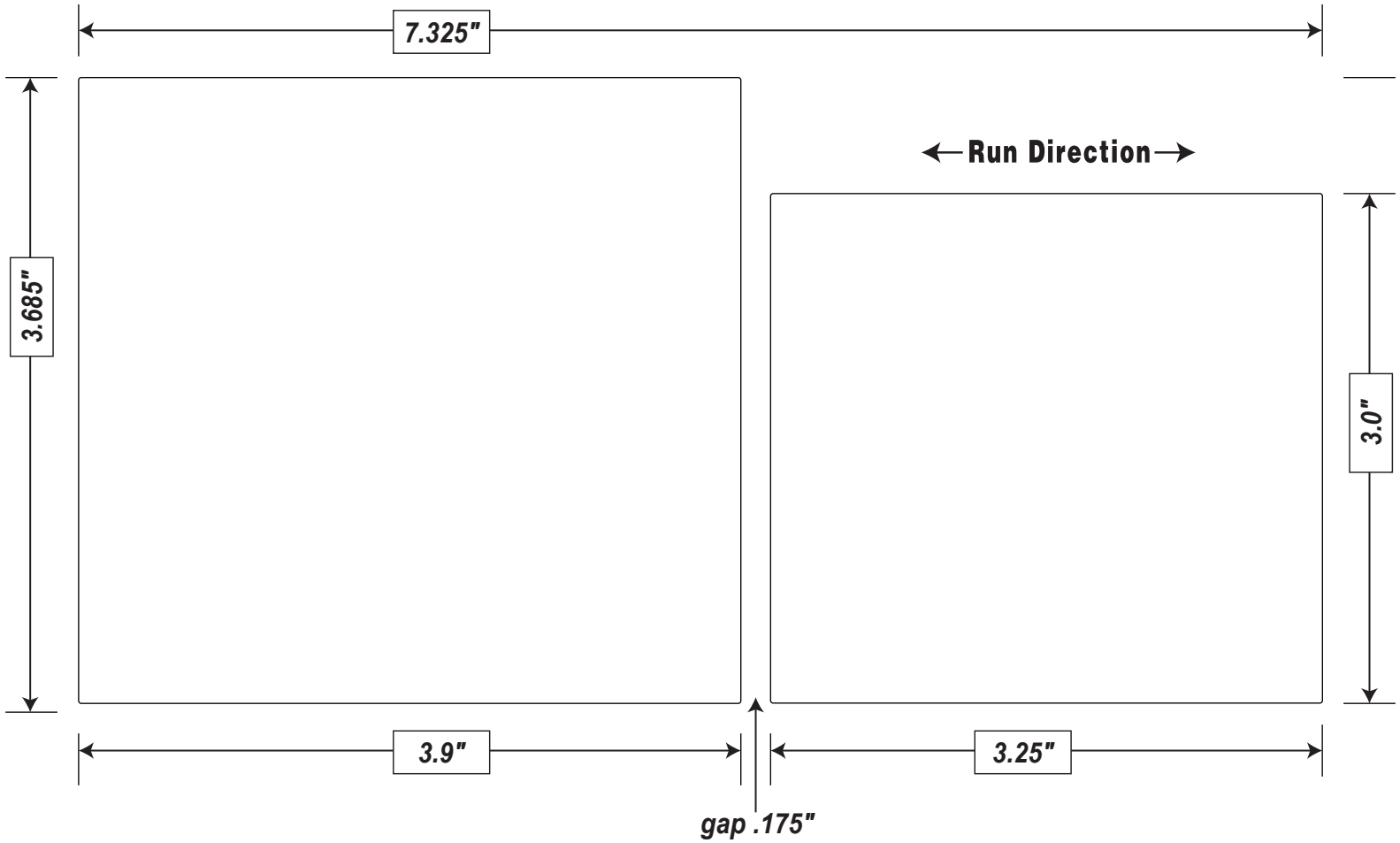

Die#: V-242
Size: 3.5" x 8.125"
Corners: .0156"
Material Type: Classic Crest
Varnish: none
Laminate: none
Special tooling: none

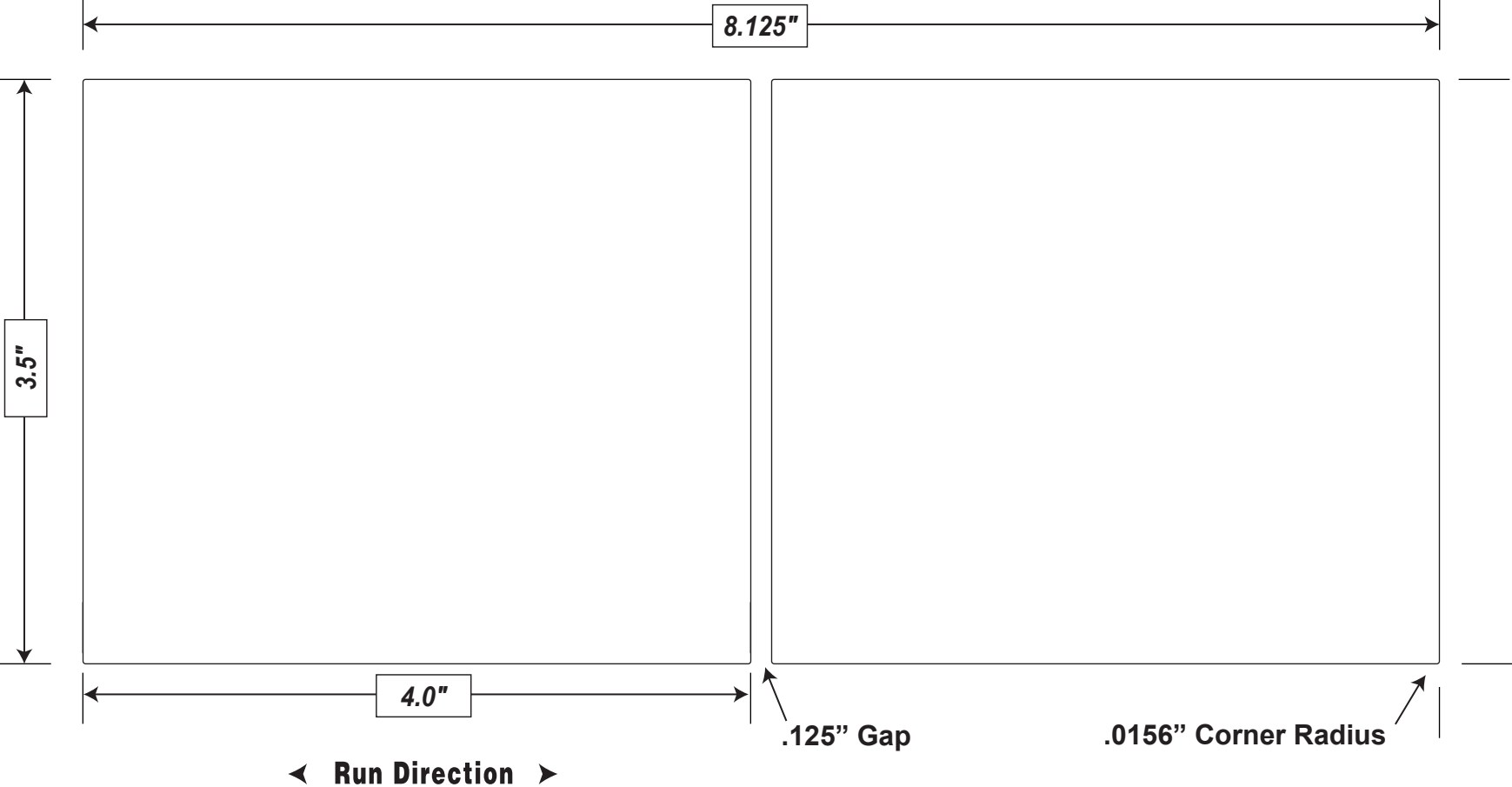

Die#: V-243

Size: 1.6374" x 10.35"

Corners: .0156"

Material Type: Classic Crest

Varnish: matte crystal

Laminate: none

Special tooling: none

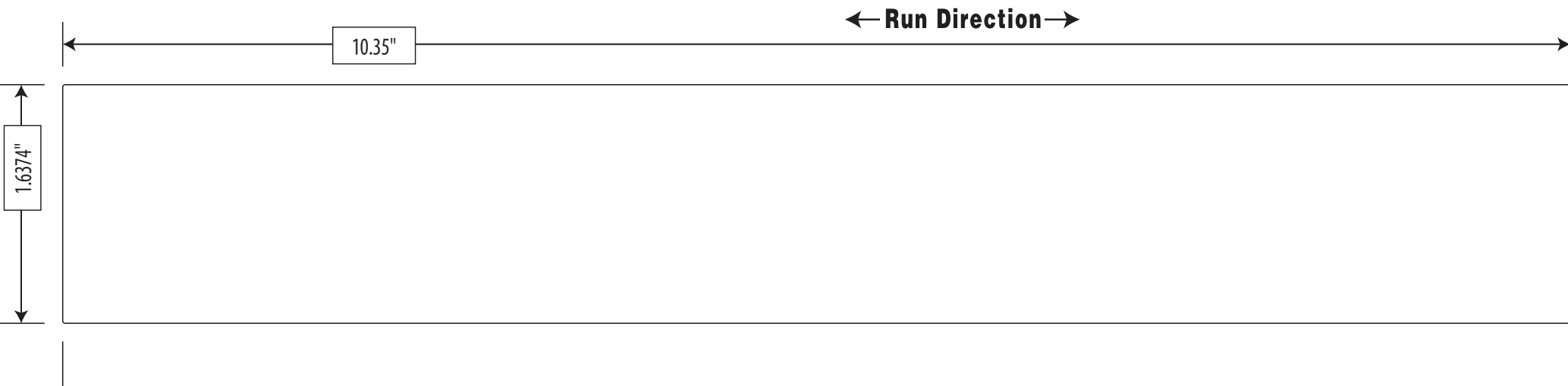

Die#: V-244
Size: 2.4175" x 10.35"
Corners: .0156"
Material Type: Classic Crest
Varnish: matte crystal
Laminate: none
Special tooling: none

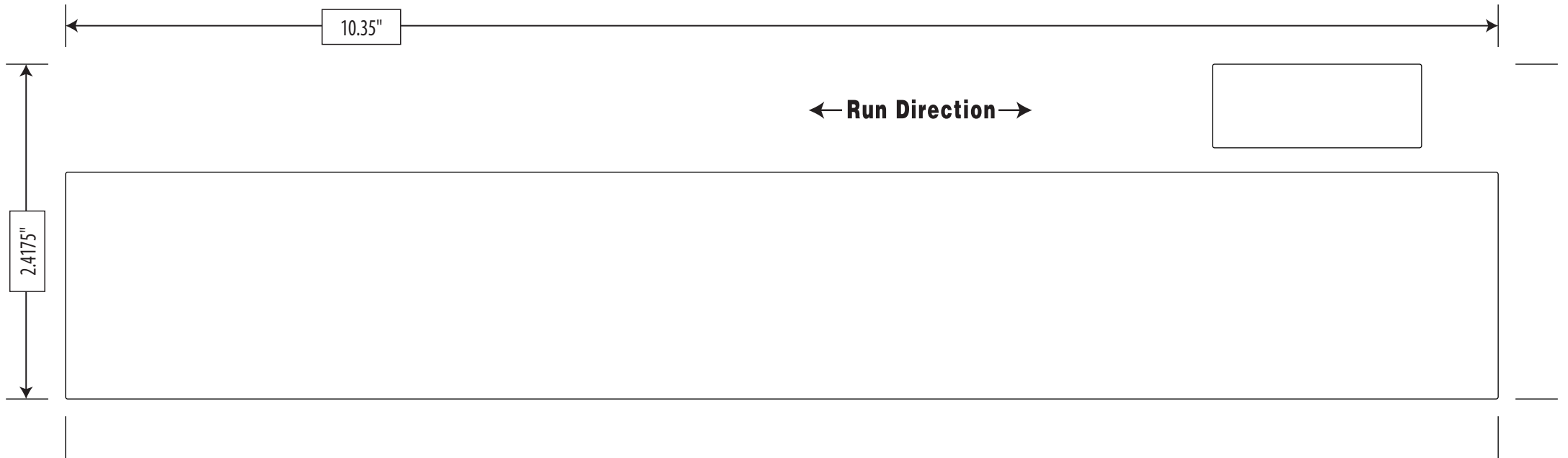

Die#: V-246
Size: 4.75" x 5.625"
Corners: 1/64"
Material Type: Classic Felt
Varnish: Gloss Crystal Barrier
Laminate: none
Special tooling: none

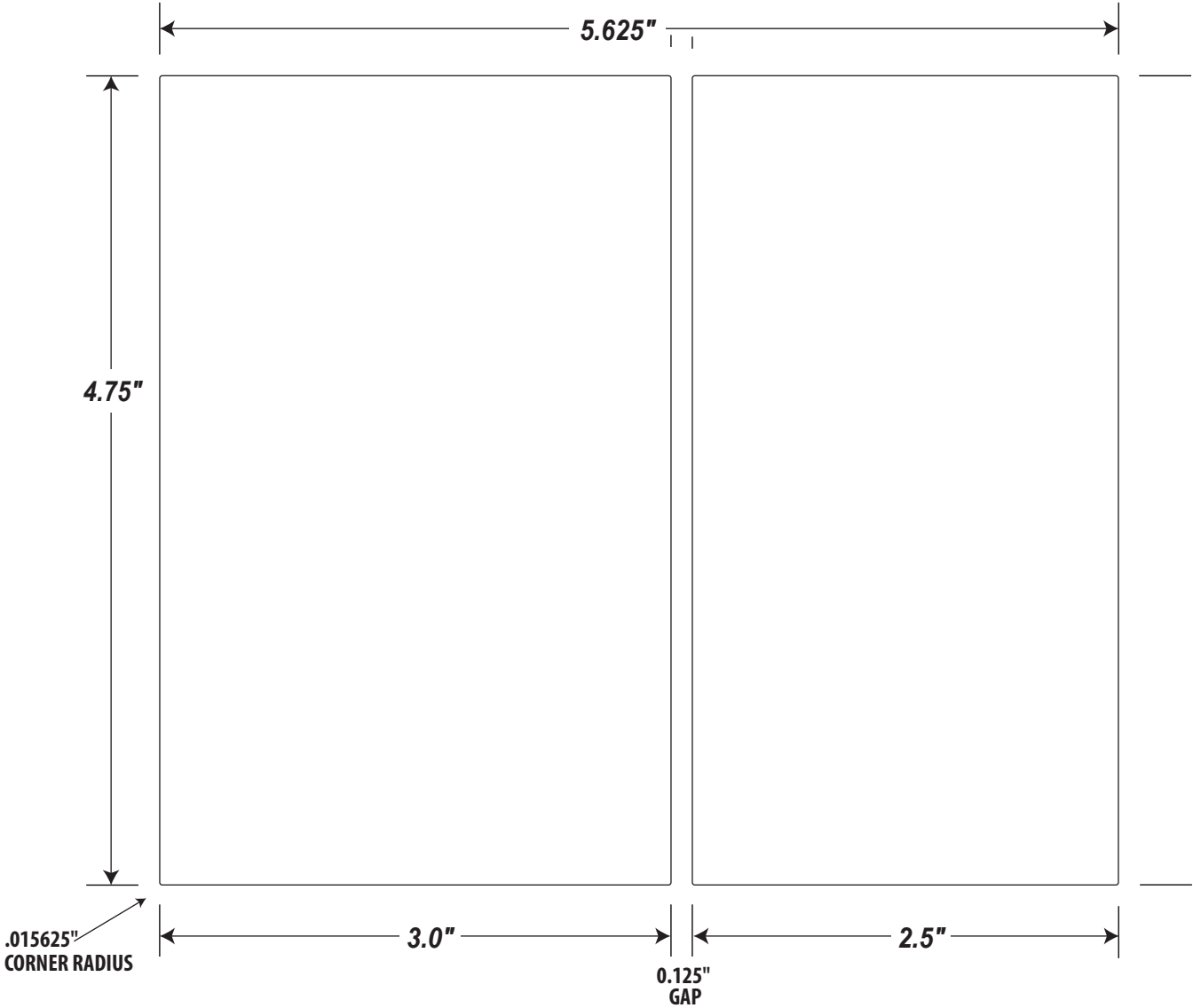

Die#: V-248
Size: 1.6374" x 9.35"
Corners: .015625"
Material Type: Classic Crest
Varnish: matte crystal
Laminate: none
Special tooling: none

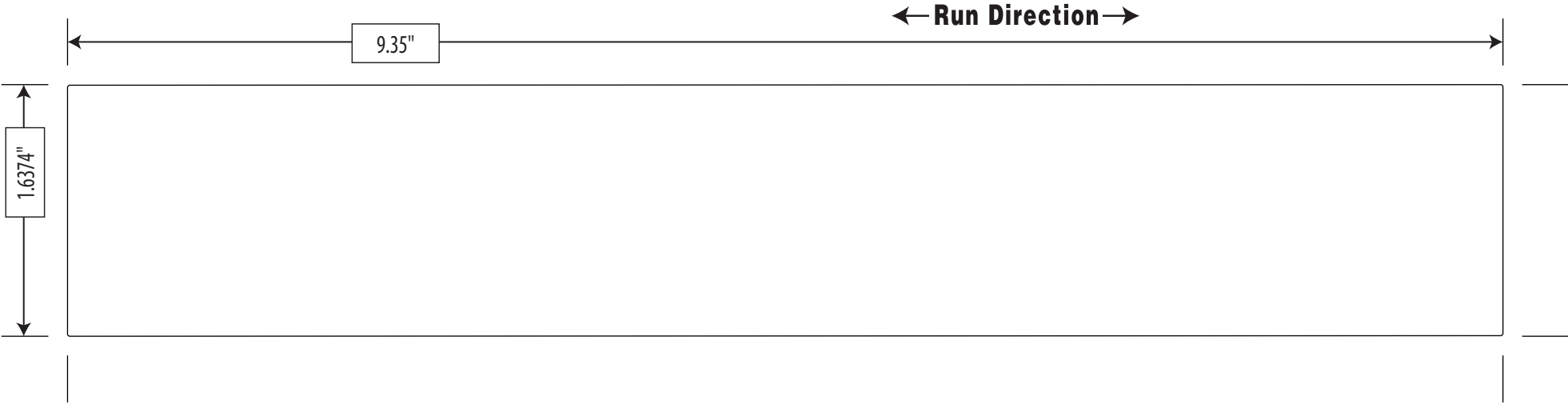

Die#: V-249
Size: 2.4175" x 9.35"
Corners: .015625"
Material Type: Classic Crest
Varnish: matte crystal
Laminate: none
Special tooling: none

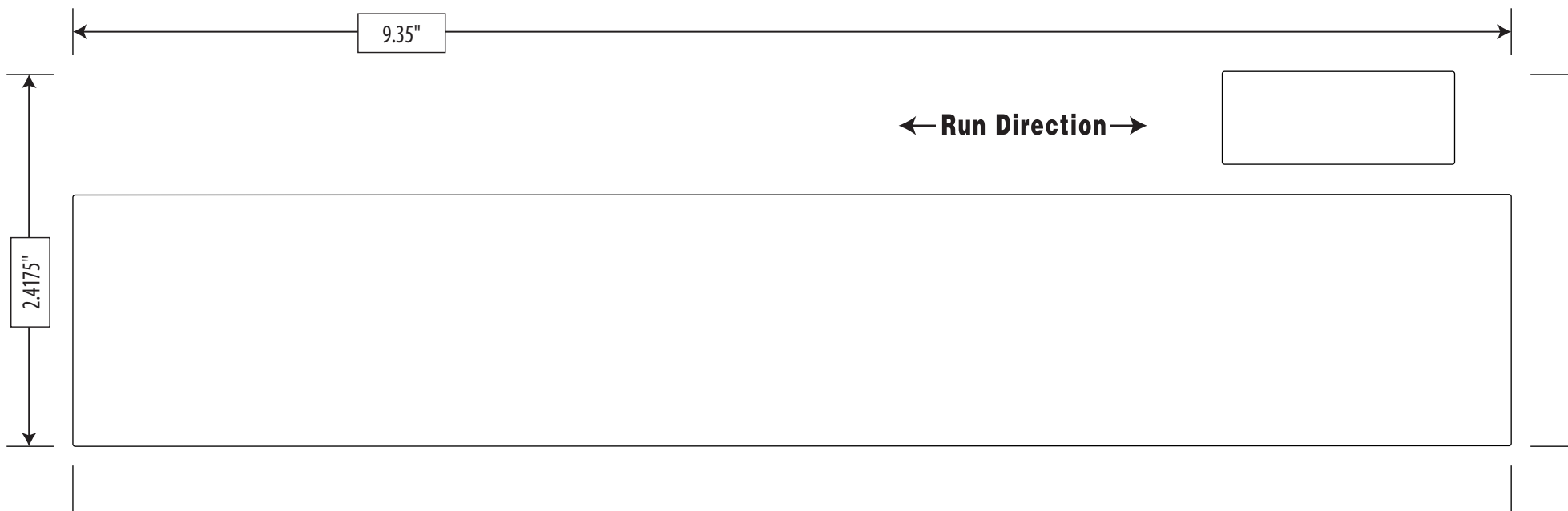

Die#: V-250
Size: 4" x 6.25"
Corners: 1/64"
Material Type: classic felt
Varnish: gloss
Laminate: none
Special tooling: none

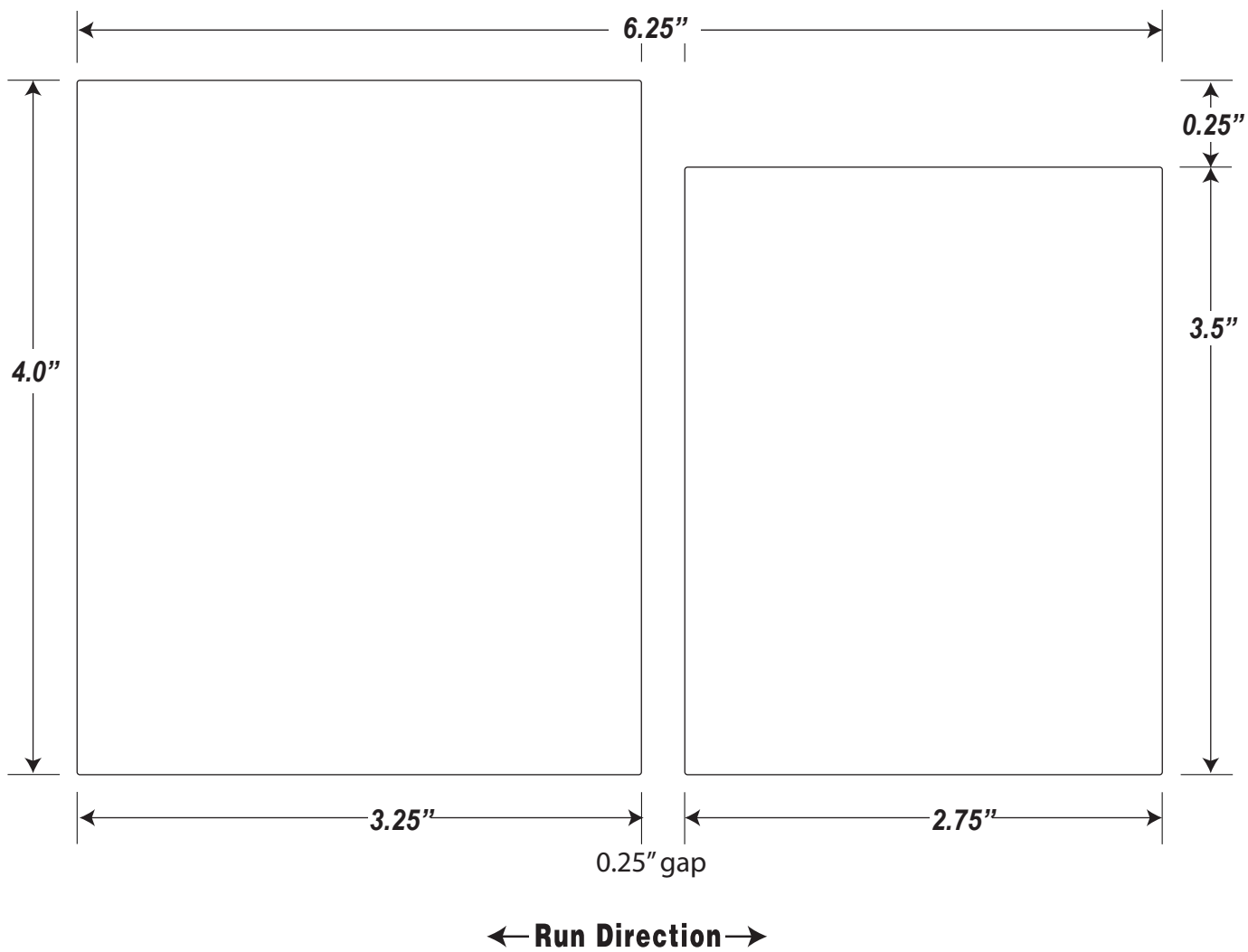

Die#/Size: V-257 3" x 7.25"
Corners: 1/32"
Material Type: Estate #4
Varnish: gloss crystal barrier
Laminate: None
Special tooling: None

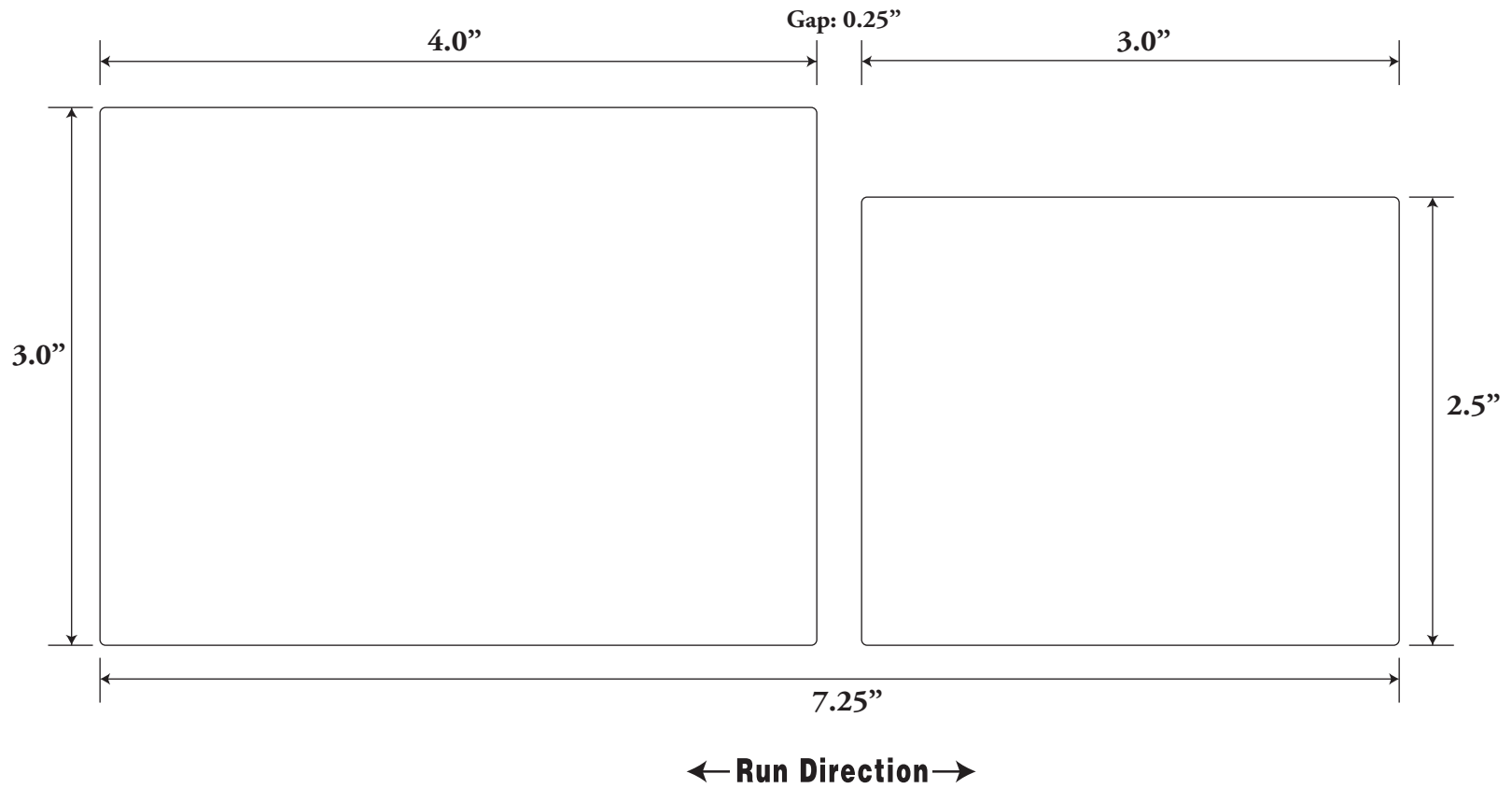

DIE# V-259

SIZE: 3.5" X 6.46875"

CORNERS: 0.078125" (5/64")

MATERIAL TYPE: Primax

VARNISH: Satin UV

LAMINATE: none

SPECIAL TOOLING: none

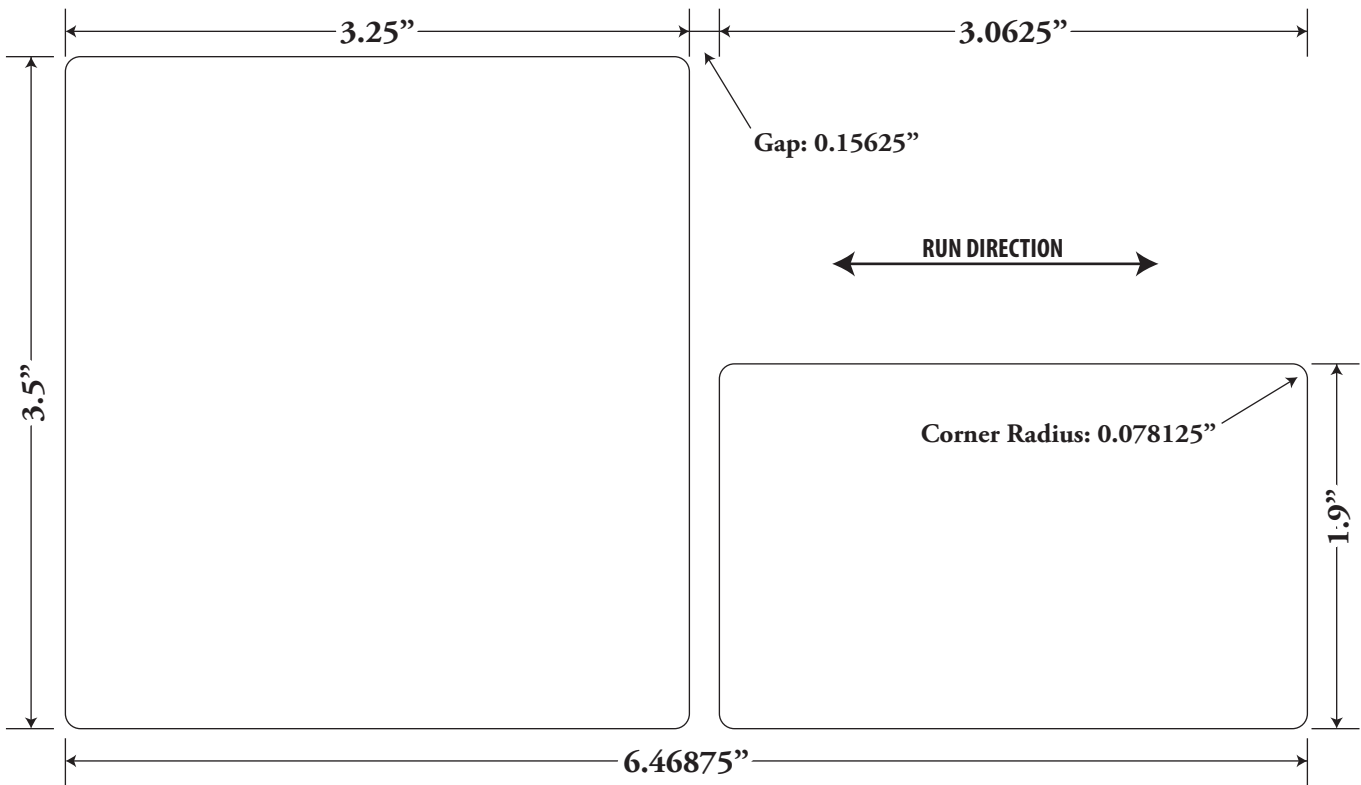

Die#/Size: V-262: 4.25" X 4.5"
Corners: .015625
Material Type: Matte Litho
Varnish/Laminate: Crystal Barrier

E

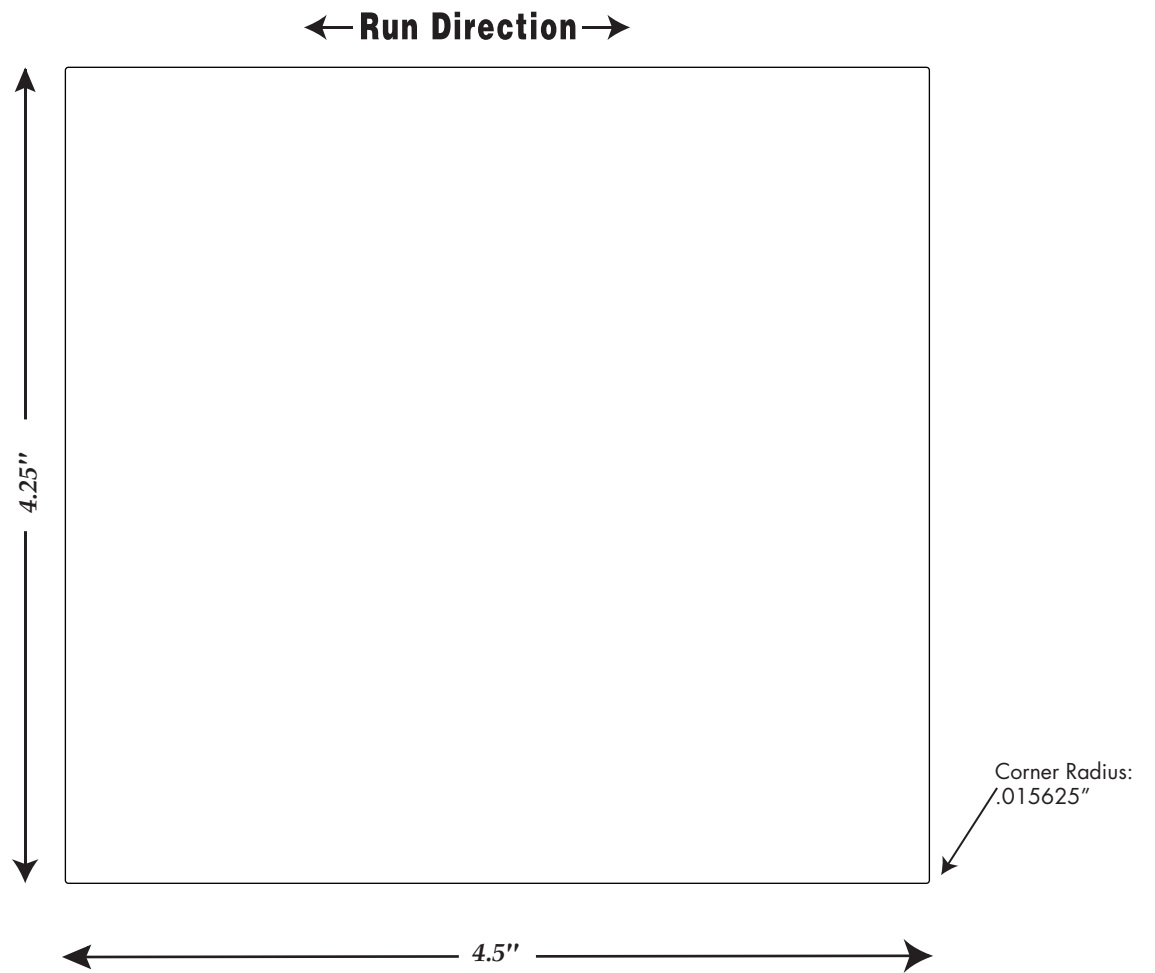

Die#/Size: V-264 3.1" x 9.5"
Corners: .0156"
Material Type: Classic Felt
Varnish: Spot UV
Laminate: Matte Crystal Barrier
Special tooling: none

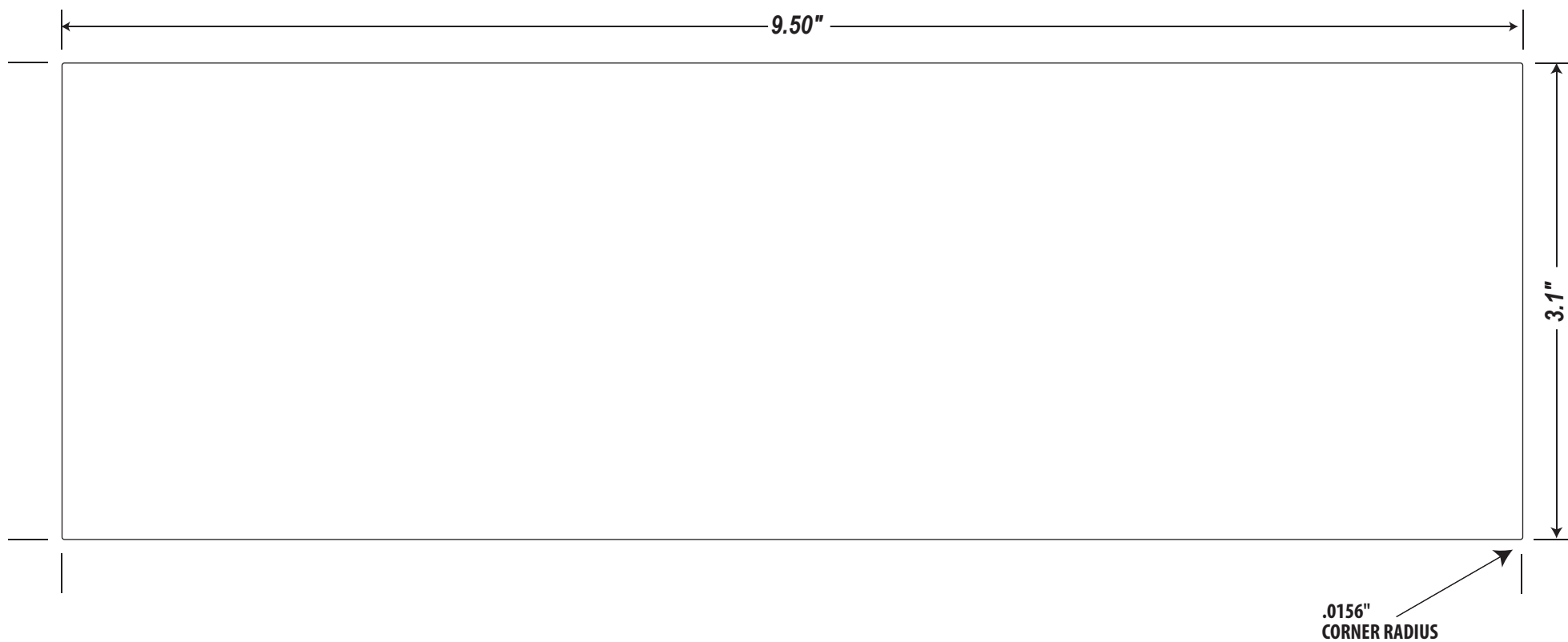

Die#/Size: V-265 3.25 x 5.375

Corners: .015625

Material Type: Eggshell Felt

Varnish: yes

Laminate: no

Special tooling: NEW DIE

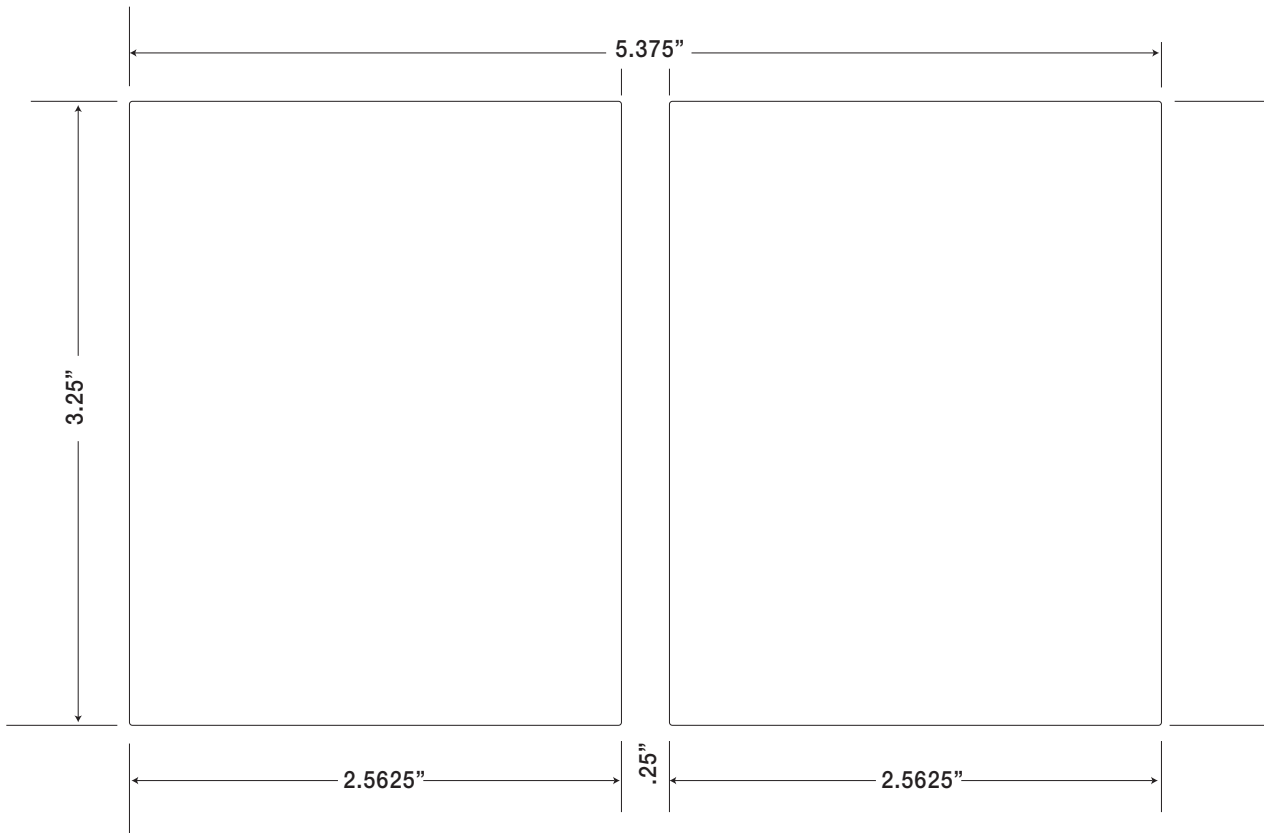

Die#/Size: V-266: 3.4399" X 7.4863"
Corners: 1/64"
Material Type: Classic Felt
Varnish: Satin Coat
Laminate: None
Shape: Special

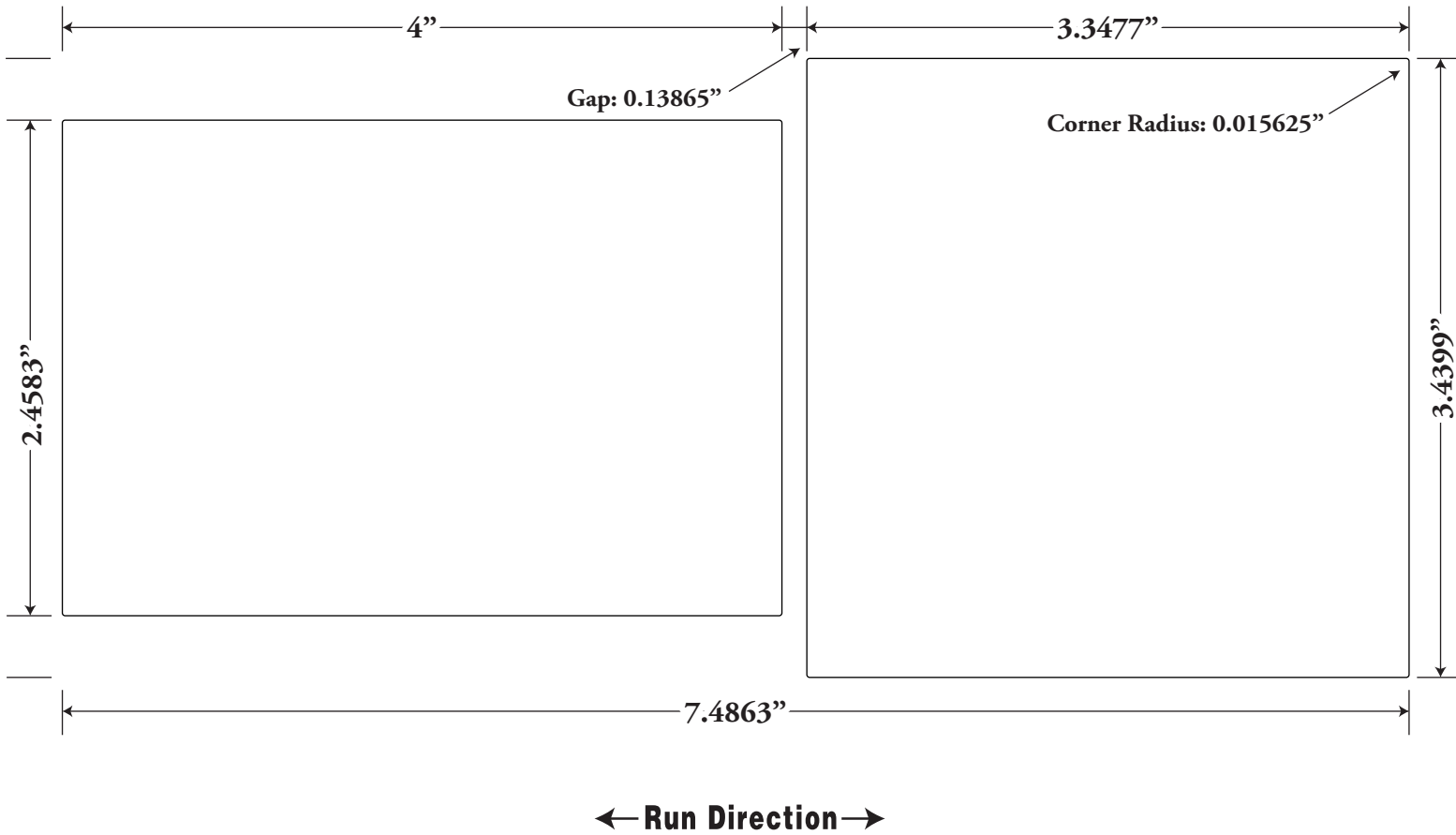

Die#: V-284
Size: 3.5" x 7.875"
Corners: 1/64"
Material Type: Gloss
Varnish: Scuff Resistent
Laminate: none
Special tooling: none

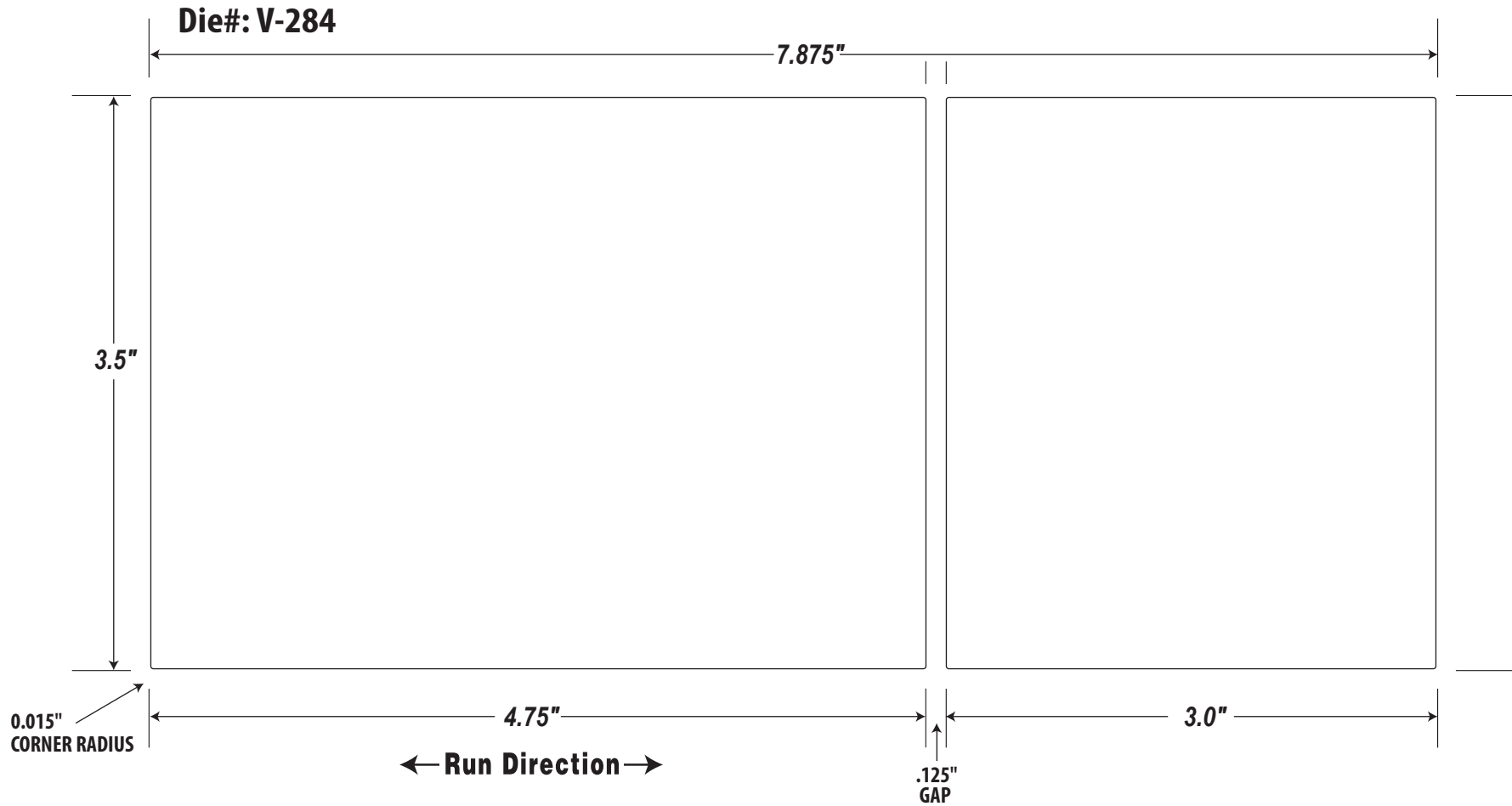

Die#: V-285
Size: 4.0" x 6.75"
Corners: 1/64"
Material Type: Matte Litho
Varnish: Matte Crystal
Laminate: none
Special tooling: none

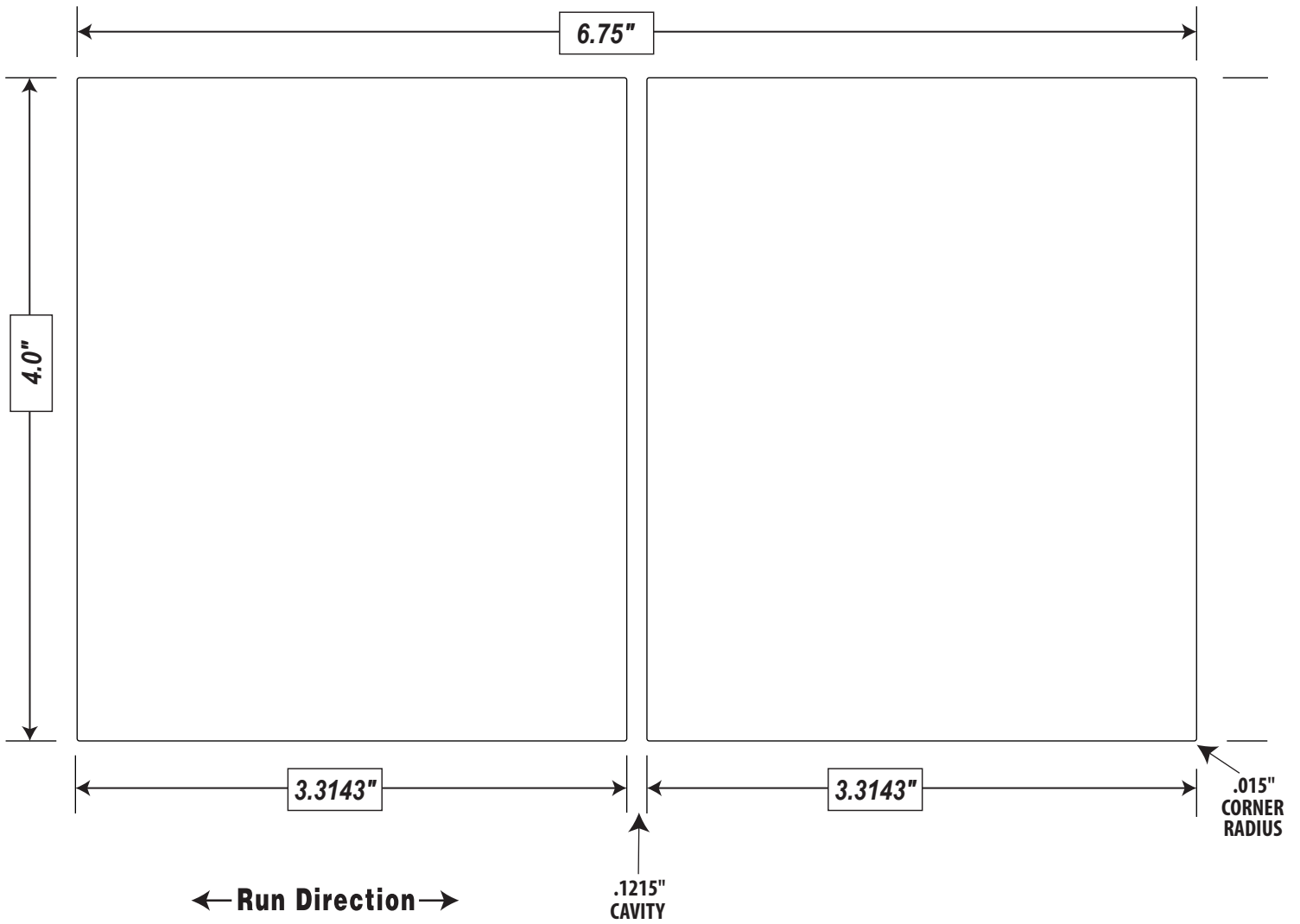

Die#/Size: V-293 3.6125" X 5.625"
Corners: 1/64"
Material Type: Classic Linen
Varnish: Satin 2
Laminate: None

